

















Name	No.	Picture	6 x 8	Extra 2 m	Extra 1 m
Pipe Φ 38 (1895mm)	1		10	2	2
Pipe Φ 38 (1930mm)	2		34	7	
Pipe Φ 38 (930mm)	3				7
Triple roof connector Φ 42	4		4		
Quad roof connector Φ 42	5		6	2	2
Corner foot	6		2		
Corner foot	7		2		
Foot	8		6	2	2
Entrance foot	9		4		
Roof enforcement Φ 25 (320mm)	10		5	1	1
Peg 8x300mm	11		4		
Peg 6x180mm	12		10	2	2
Peg 4x180mm	13		48	6	6
String	14		4		
Screw M6x35	15		10	2	2
Screw M6x50	16		126	28	28
Bracket to secure entrance	18		16		

STEP 1

The tent should be deployed on the flat surface.

For the tents with the even length of the side eg. 8m, 10m, 12m, 20m, 30m,

Distribute the parts as pictured below. Connect all the dia. 38 mm (Φ) tubes with the connectors using the M6x50 screws.

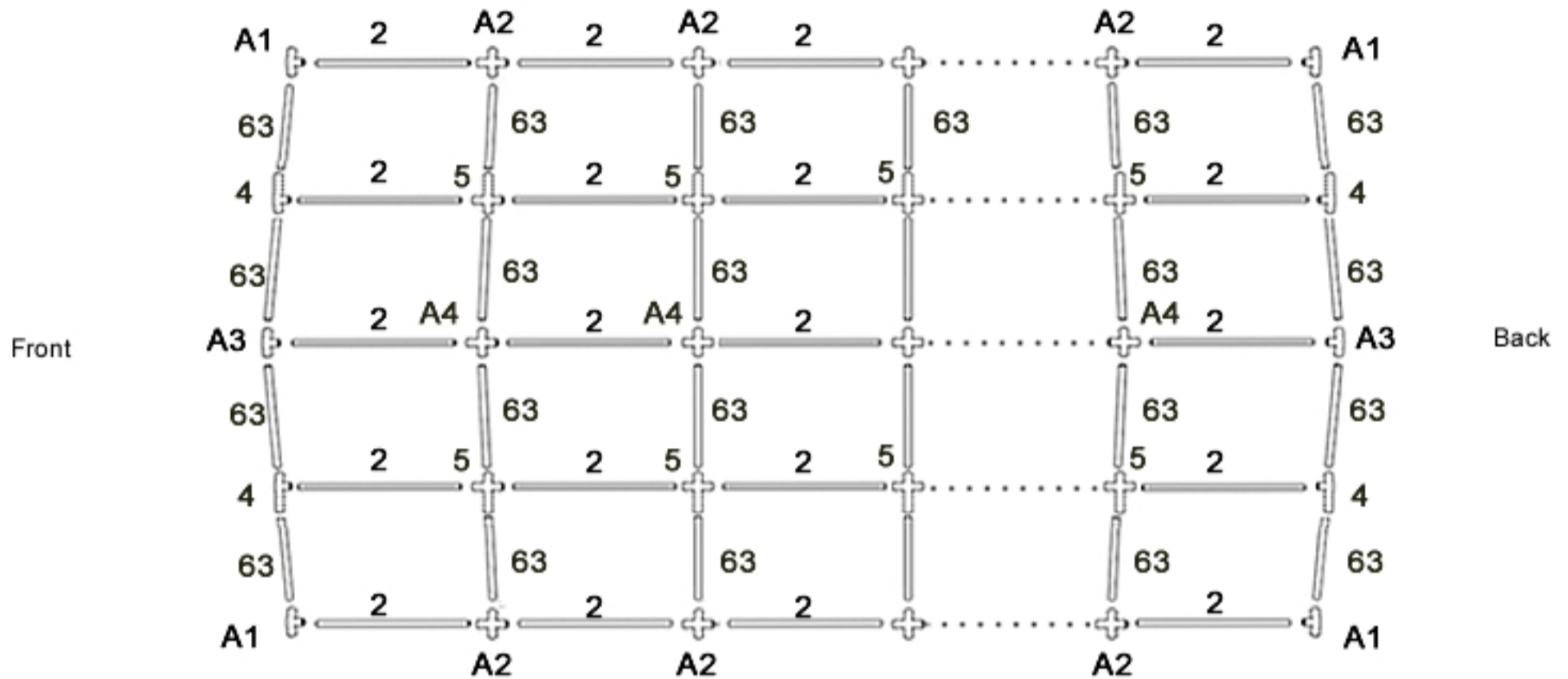

For the tents with the uneven length of the side eg. 9m, 11m, 13m, 21m, 31m.....

Distribute the parts as pictured below. Connect all the dia. 38 mm (Φ) tubes with the connectors using the M6x50 screws.

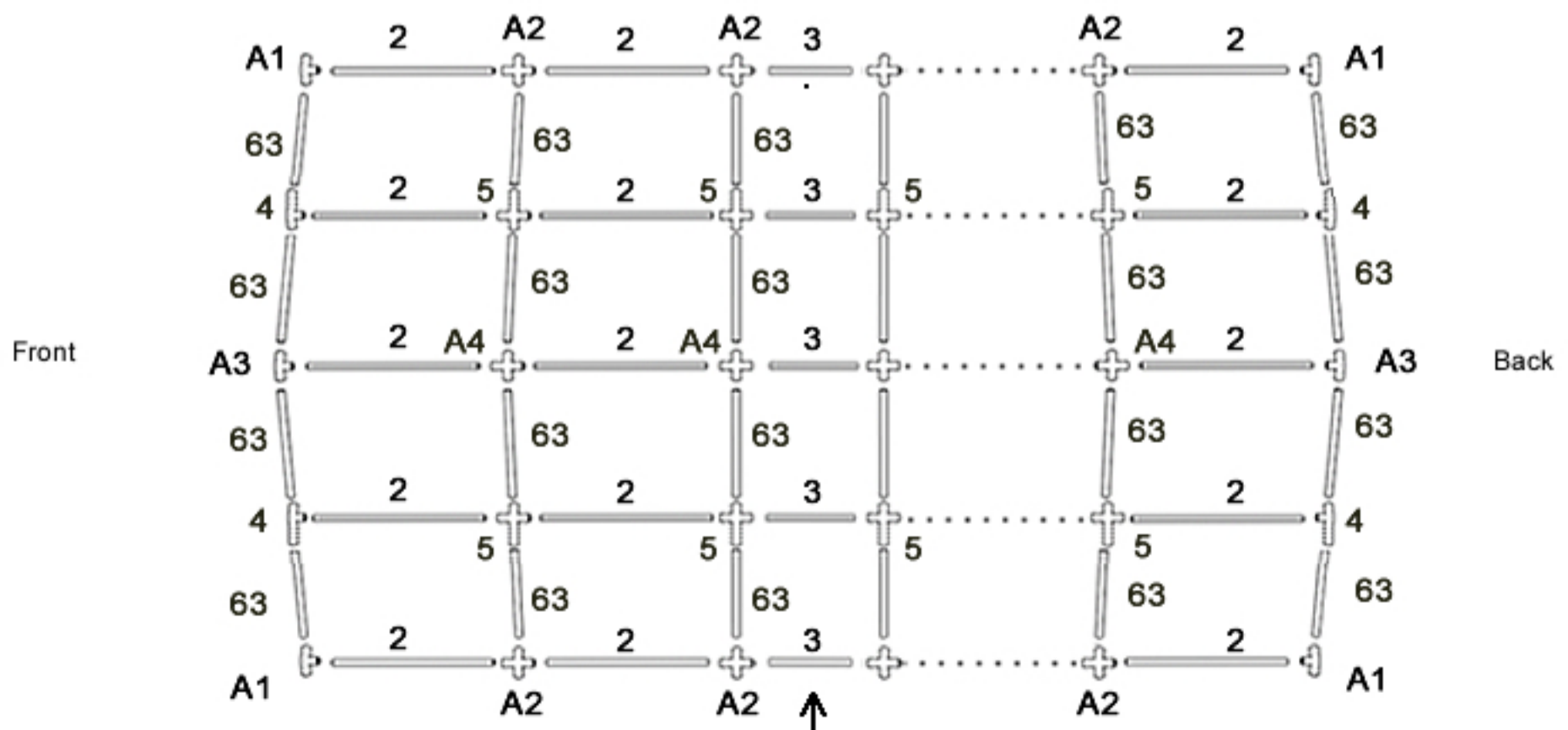

The extension tube should be located in the third section.

STEP 2/a

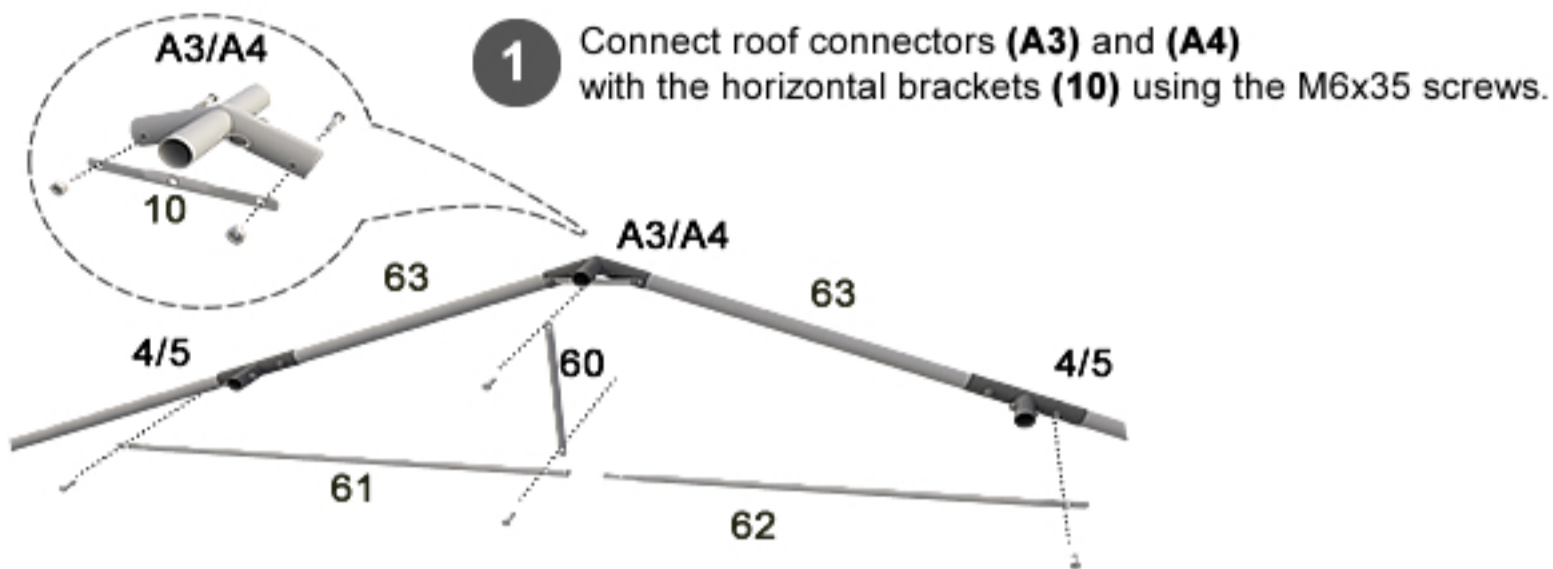

- 2** Connect the brackets **(61)** and **(62)** using the M6x35 screws. Connect the obtained construction to the **lower part of connectors (4 or 5)**. Using the vertical bracket **(60)** connect the horizontal bracket **(10)** to the previously assembled parts.

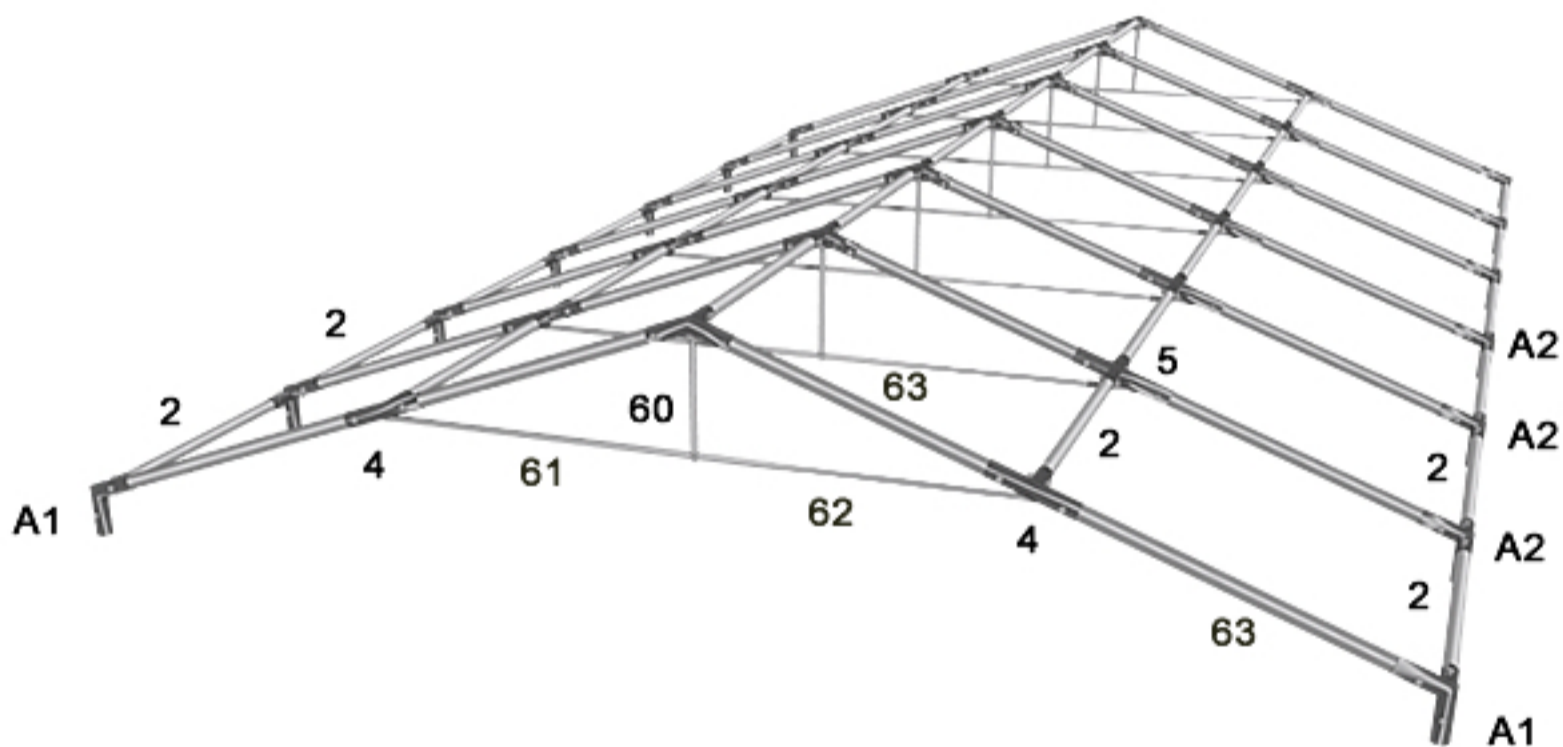

STEP 3

Gently lift the tent on one side and mount the pipe **(1)**. The single hole in the tube should be facing downwards. Next, lift the tent on the other side and mount the pipe **(1)** there.

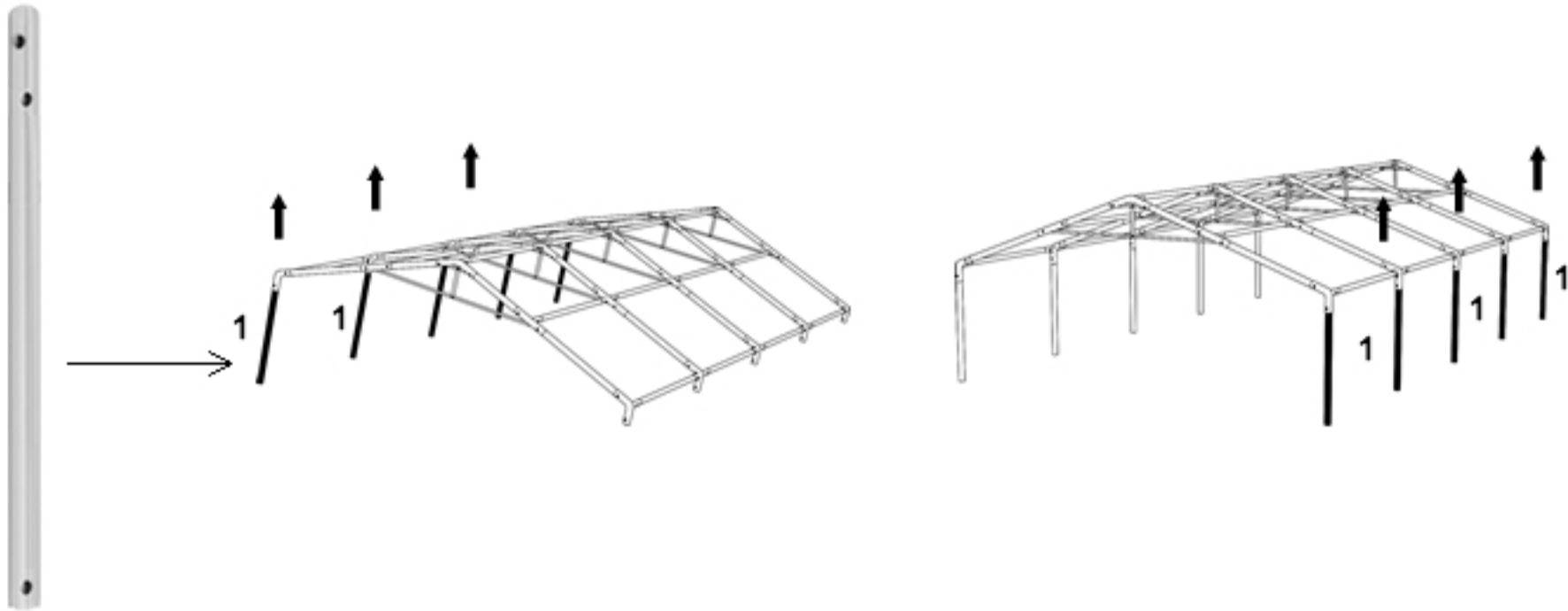

STEP 4

Mount the corner feet **(6)** diagonally (same applies to feet **7**). On the sides of the tent mount the feet **(8)** and connect them to the tubes **(2)**. For the tents with uneven length of the side, the one meter extension should be mounted in the third section. The feet **(9)** should be installed on the front and on the back of the construction and connected to the corner feet via tube **(2)**. All the feet should be securely mounted to the ground.

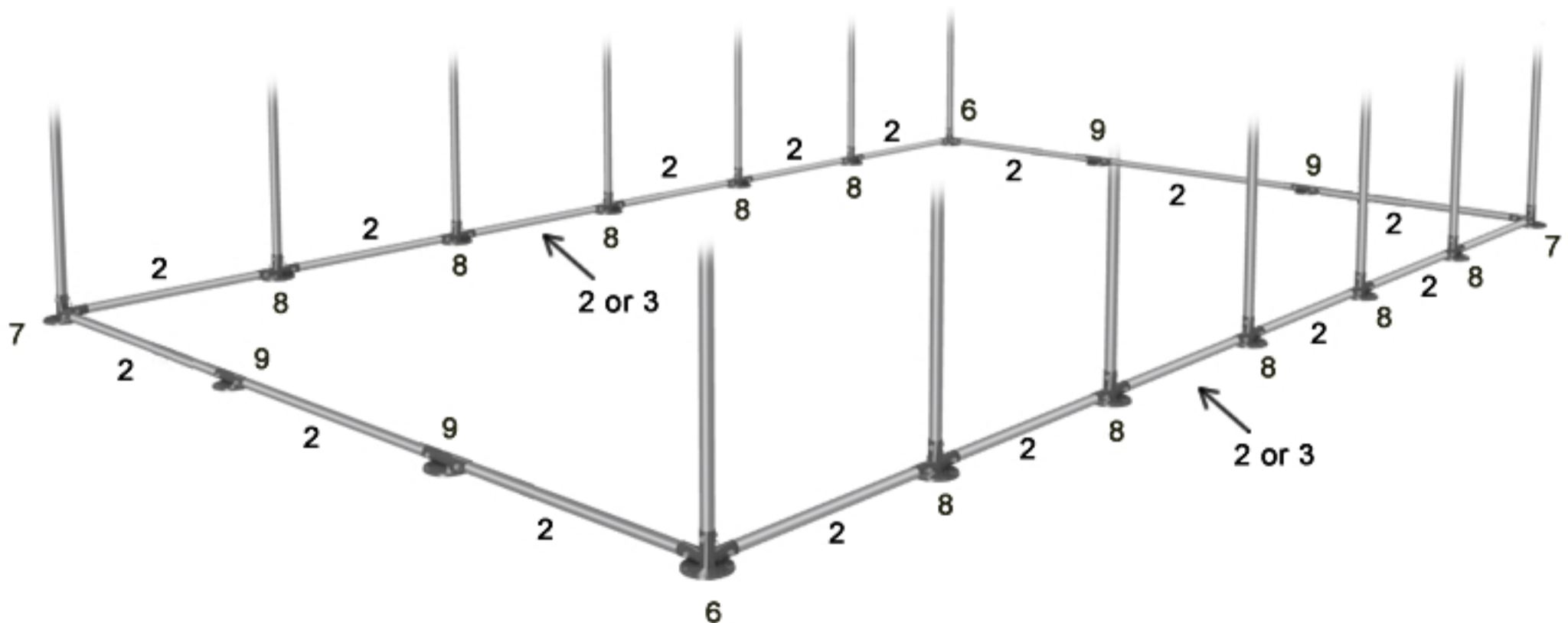

STEP 5

Side panels should be mounted directly to the roof using the velcro stripes. Sides of the panels should be mounted using the elastic rubber with the ball.

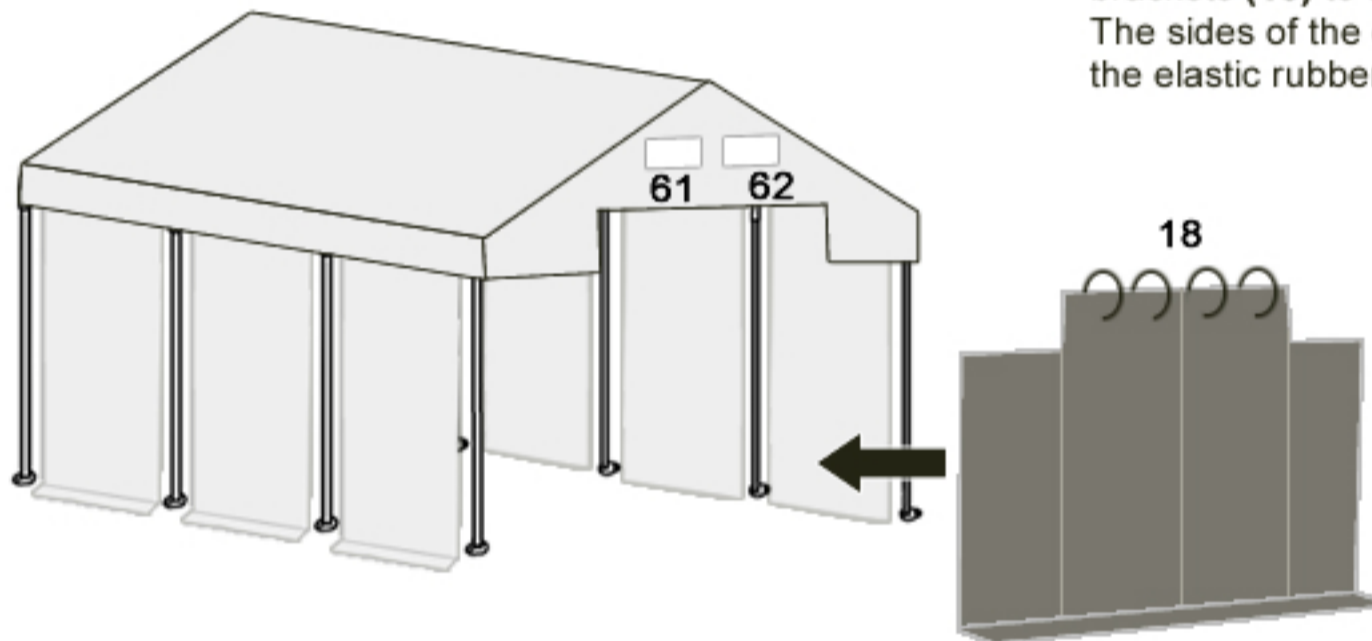
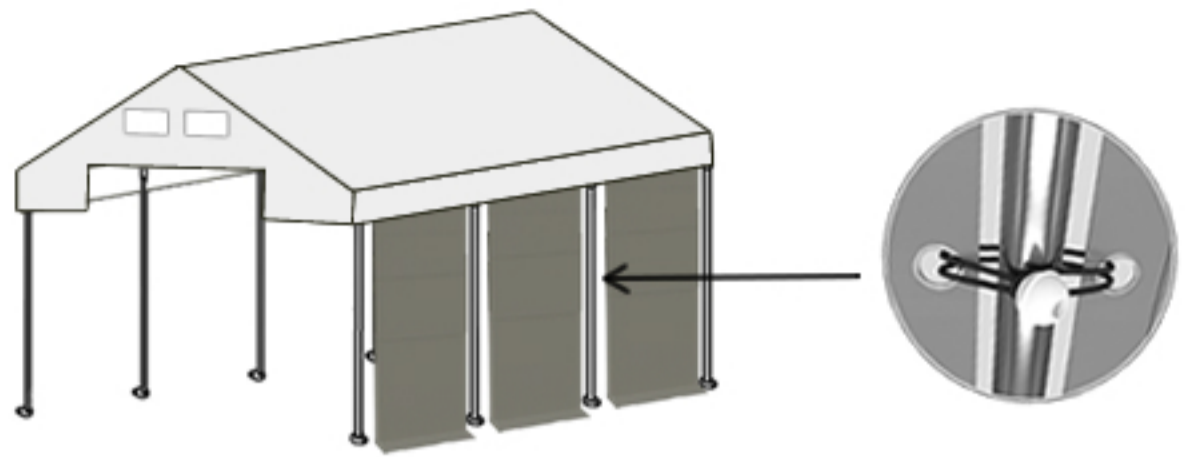

Fix the upper part of the entrance using the metal brackets **(18)** to the horizontal tube **(61 and 62)**. The sides of the entrance should be mounted using the elastic rubber with the ball.

Mount the masking stripes. Four wider masking stripes should be installed on the each corner of the tent.

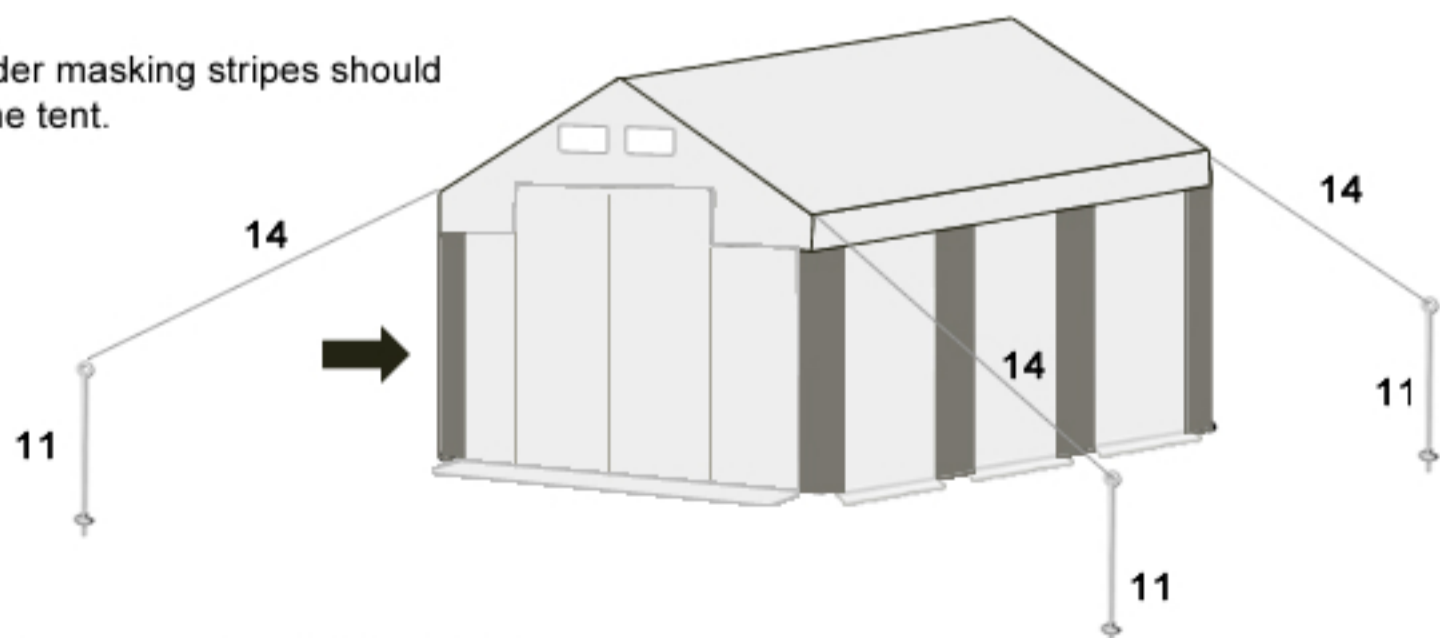

Fix the roof pulls on the corners of the tent using the **(14)** and **(11)** parts. All the lines should be tight.