

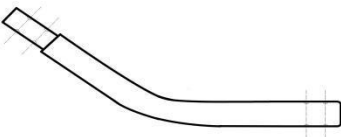











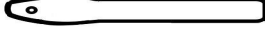
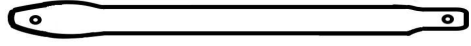
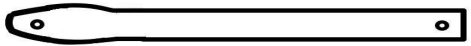
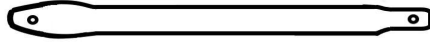
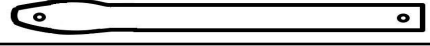
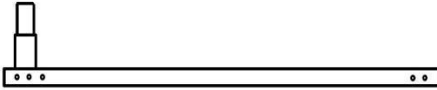
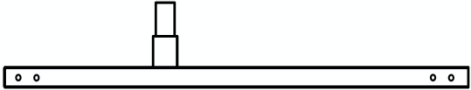
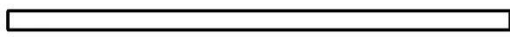

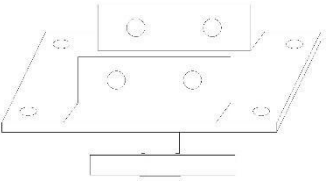

Container Tent Assemble Manual

Main Frame Part list

Description	No.	Drawing	10x6.1 qty
Main frame bar 1020mm	1		8
Main frame bar 2230mm	2		20
Main frame bar 2230mm	3		4
Connection bar 2068mm	4		18
Connection bar 2068mm	5		9
Roof reinforcement 400mm	6		2
Roof reinforcement 1755mm	7		4
Roof reinforcement 1755mm	8		2
Roof reinforcement 1483mm	9		4
Roof reinforcement 1483mm	10		4
Bottom bar 1530mm	11		4
Bottom bar 1530mm	12		4
Fabric tighten bar 1900	13		6
Container fixing part	14		6
Bottom bar connection plate 160mm	15		6
corner fastener			4
6x1800mm Rope			4
Screw M10x90 (tube 76mm)			36
Screw M10x120 (tube 11,12)			24

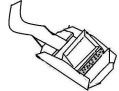
Screw M10x140(tube 76mm+ 50mm)			36
Screw M10x65(tube 7,8,9)			2
M10 U shape Screw(part 14)			6
Screw M10x50(tube 9, 10)			4
Buckle			18
Tie down kit			4
Ring screw fasten with tie down kit			4

20' container bottom bars installation.

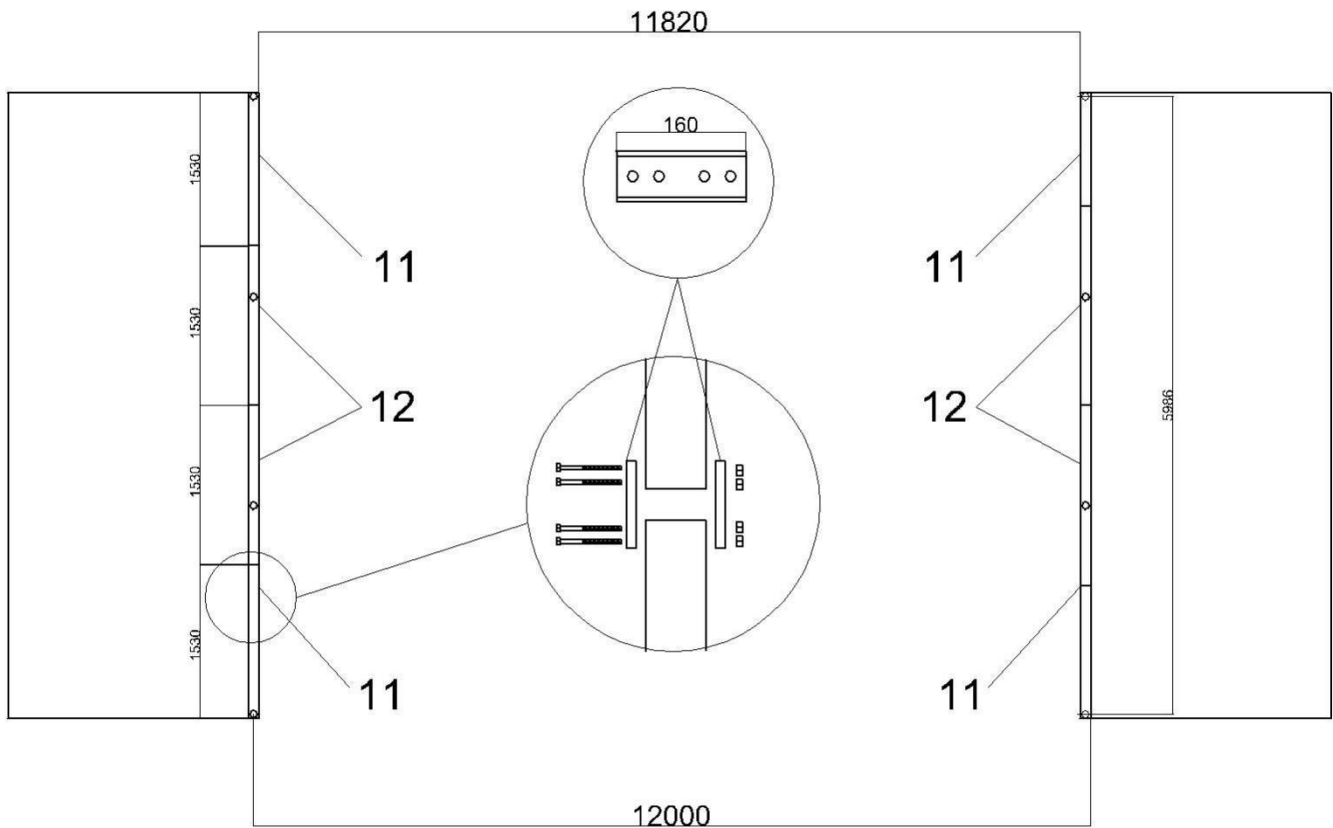

40' containers bottom bar installation.

When you need combine 6+6m tent, you must notice below point, when you have 20' container+20'container you will use 160mm connection plate to connect 2 tents' bottom bars. And if you have 40'container, you will use 80mm connection plate to connect 2 tents' bottom bars.

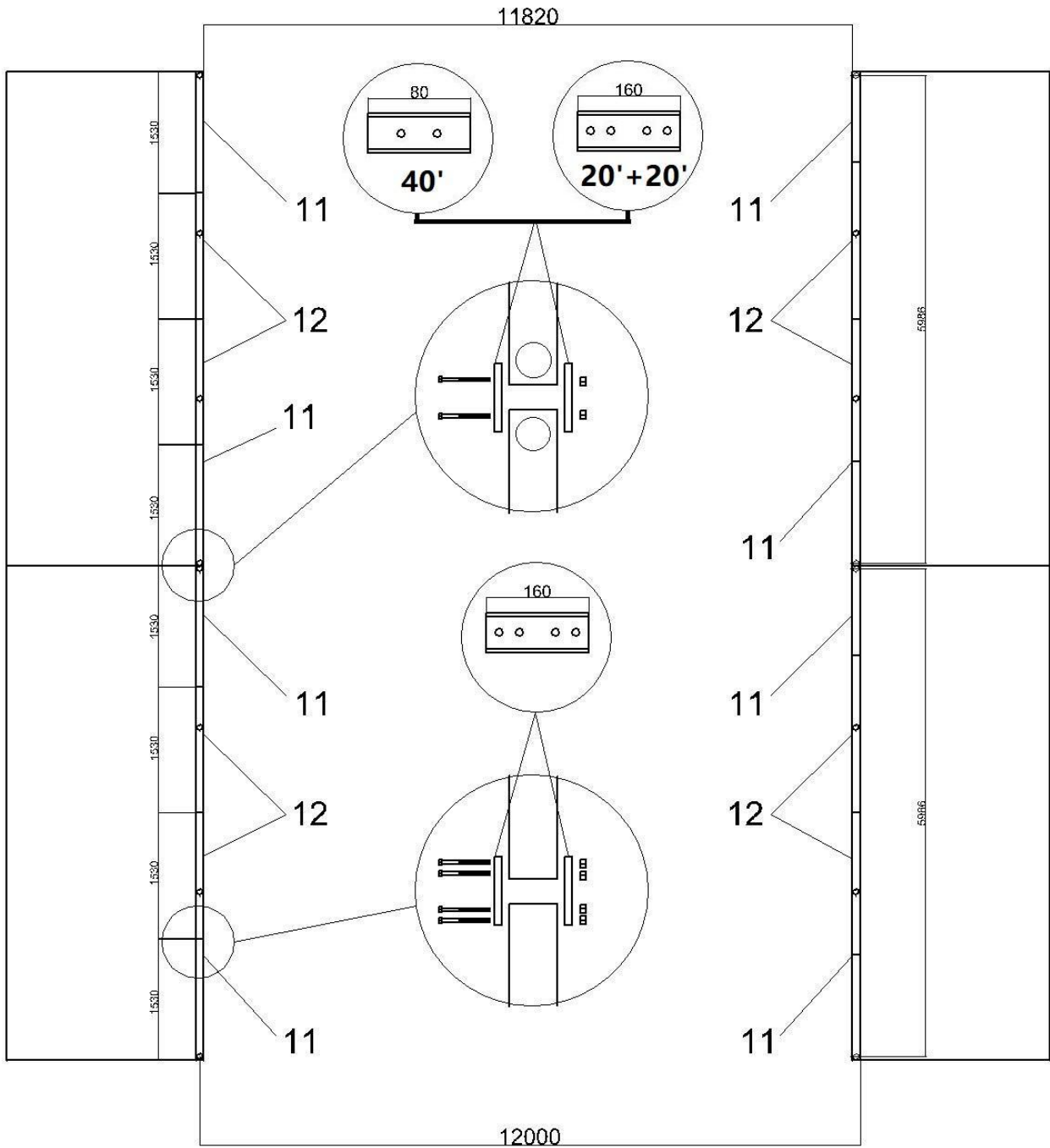

Fasten bottom bars to container

Four corners first use corner fastener, then screw bottom bar to fastener. Connect bottom bars with 160mm connection plate. and use container fixing part to firm bottom bars.

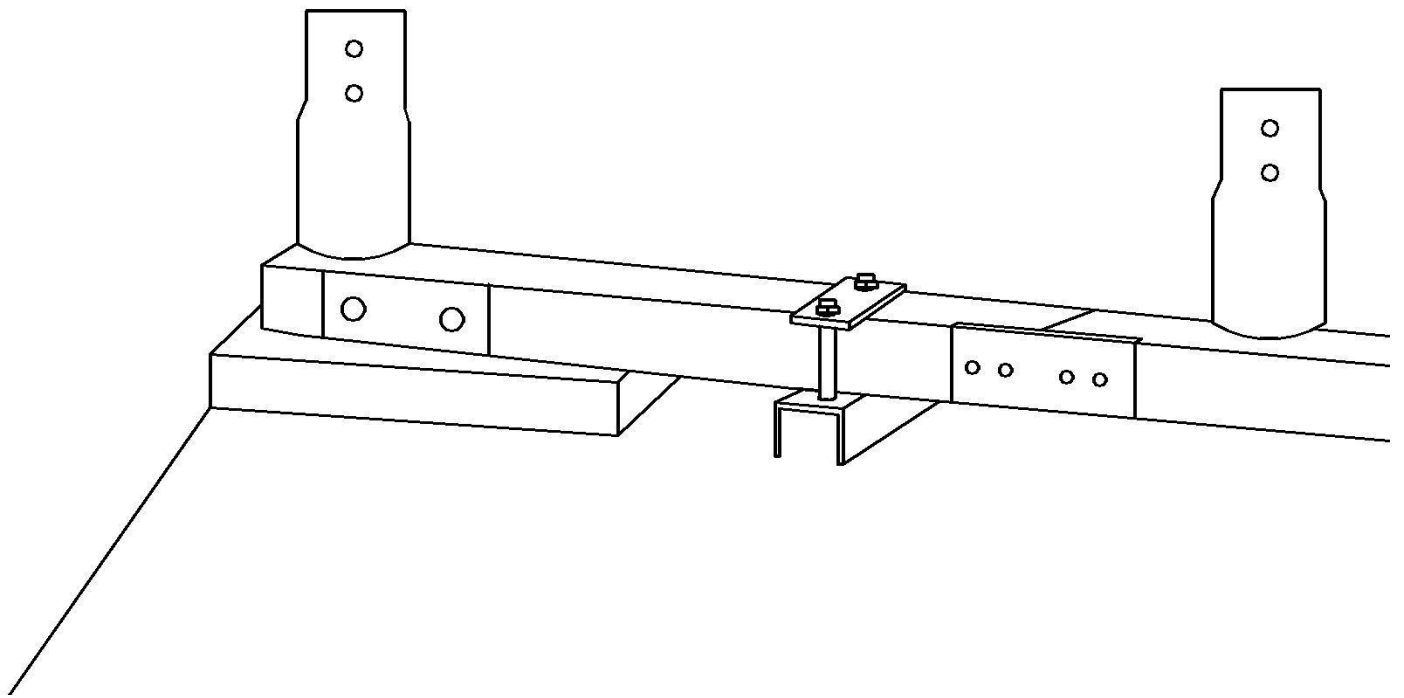
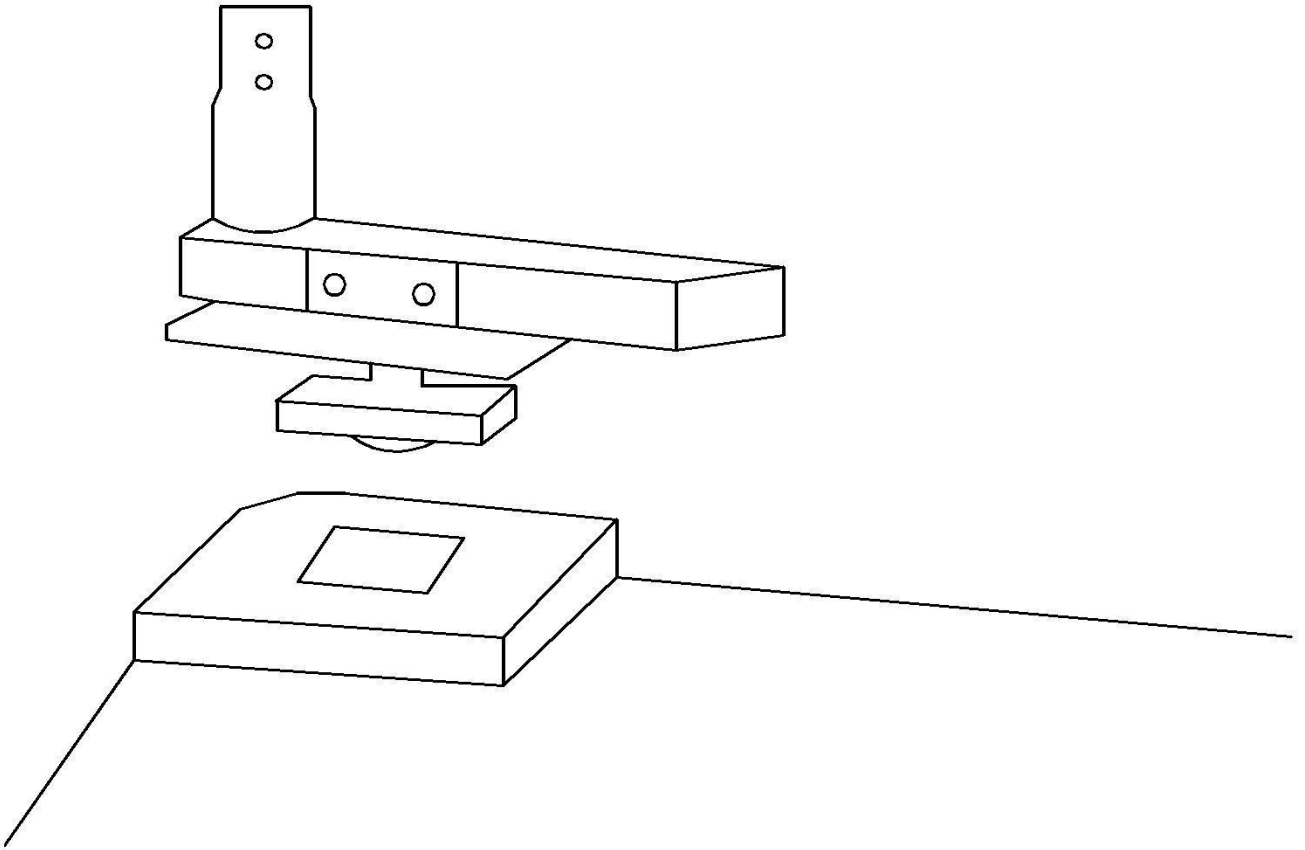



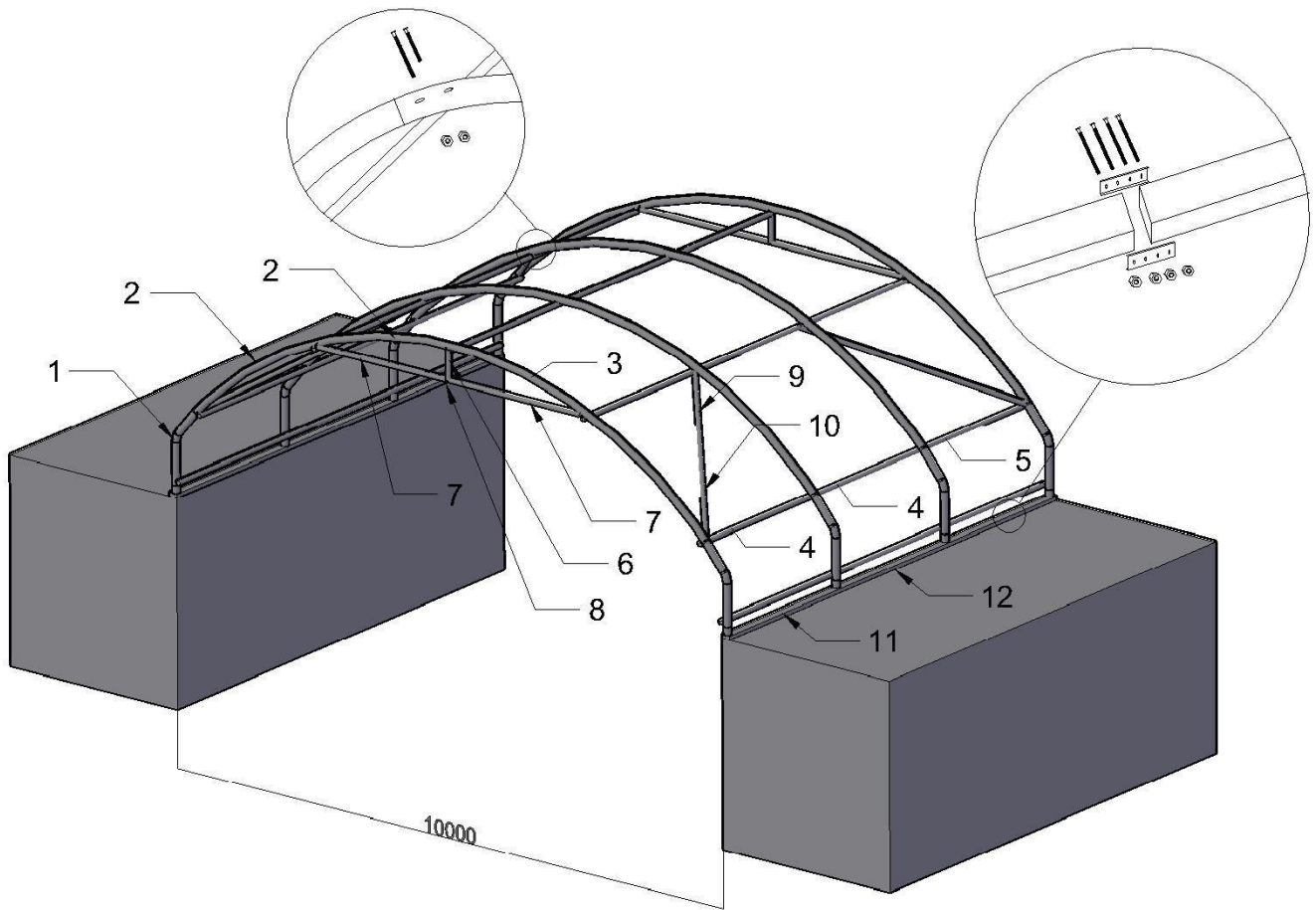







Main frame installation

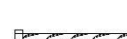

Door Frame Part List

Description	No.	Drawing	8x6.1 qty
Door frame bar 1960mm	1		6
Door frame bar 1960mm	2		4
Door frame bar 1385mm	3		2
Door frame bar 1840mm	4		2
Door frame bar 1671mm	5		12
Door frame bar 1030mm	6		2
Door frame foot	7		4
Fabric seal metal plate	8		4
Metal plate(container connect part with door frame)	9		4
Metal plate(container connect part with door frame)	10		4

Screw M10x40 (tube 76mm)		4
Screw M10x90 (tube 11,12)		28
Screw M10x100 (tube 76mm+50mm)		8
Screw M5.5x20(fabric seal plate)		52
Peg 4x180mm		22
Peg 16x600mm		2
Bracket		4
6x1160mm Rope		2
6x640mm Rope		6
6x300mm Rope		2
Bungee		2

Door frame installation

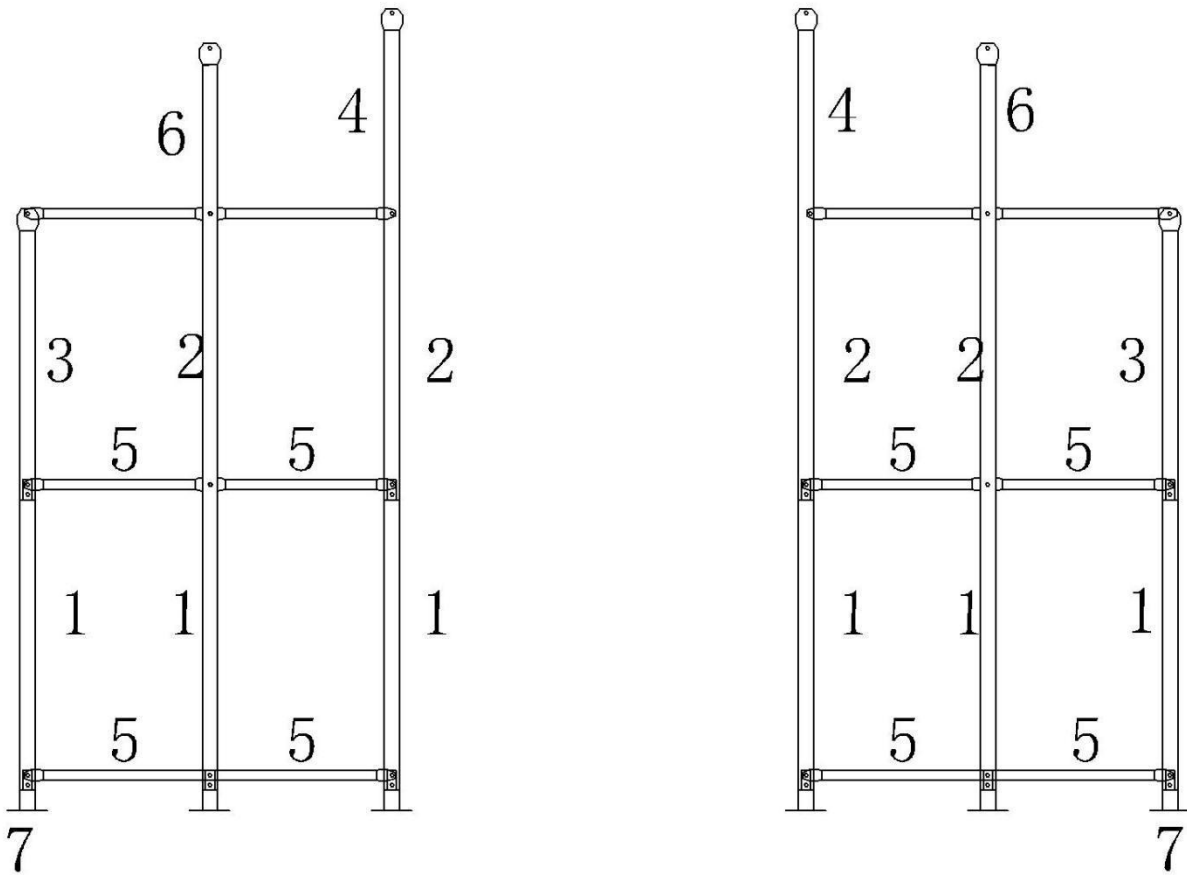

Screw metal place with door frame bar with container, you need special tool for this part installation, and this is an extra optional installation .

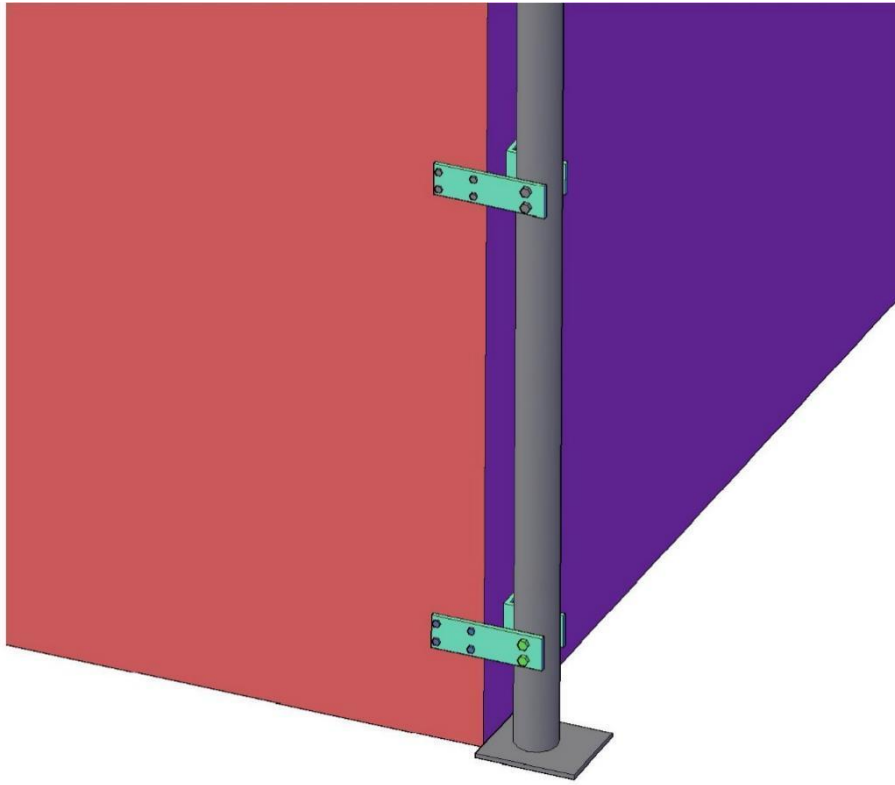



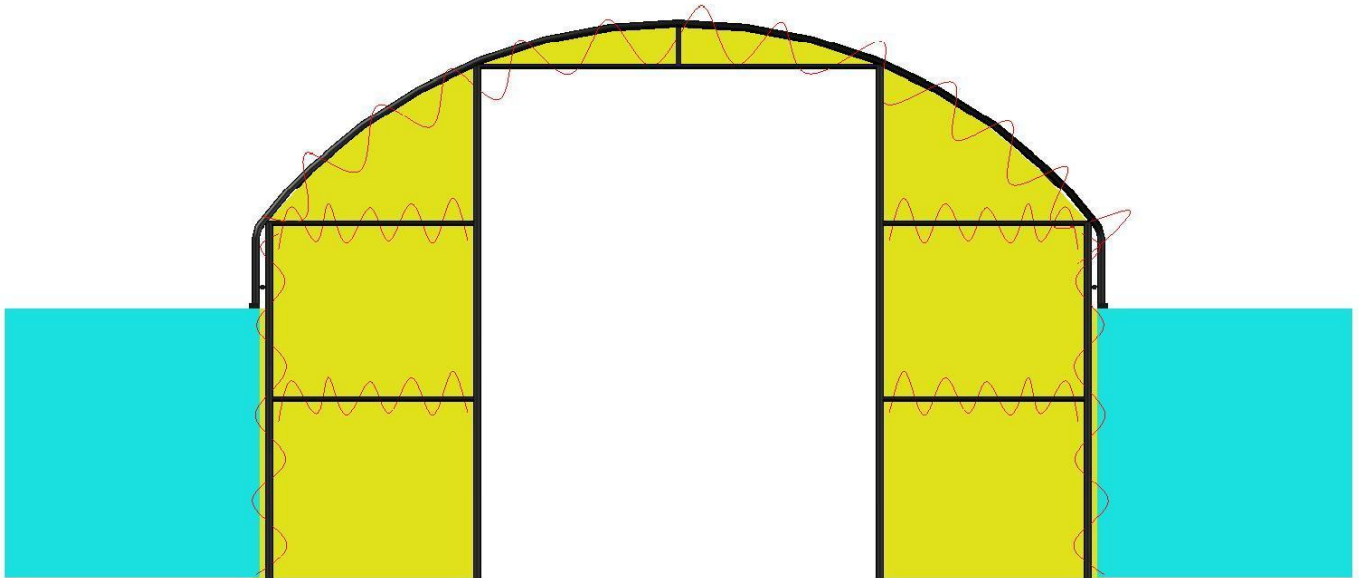



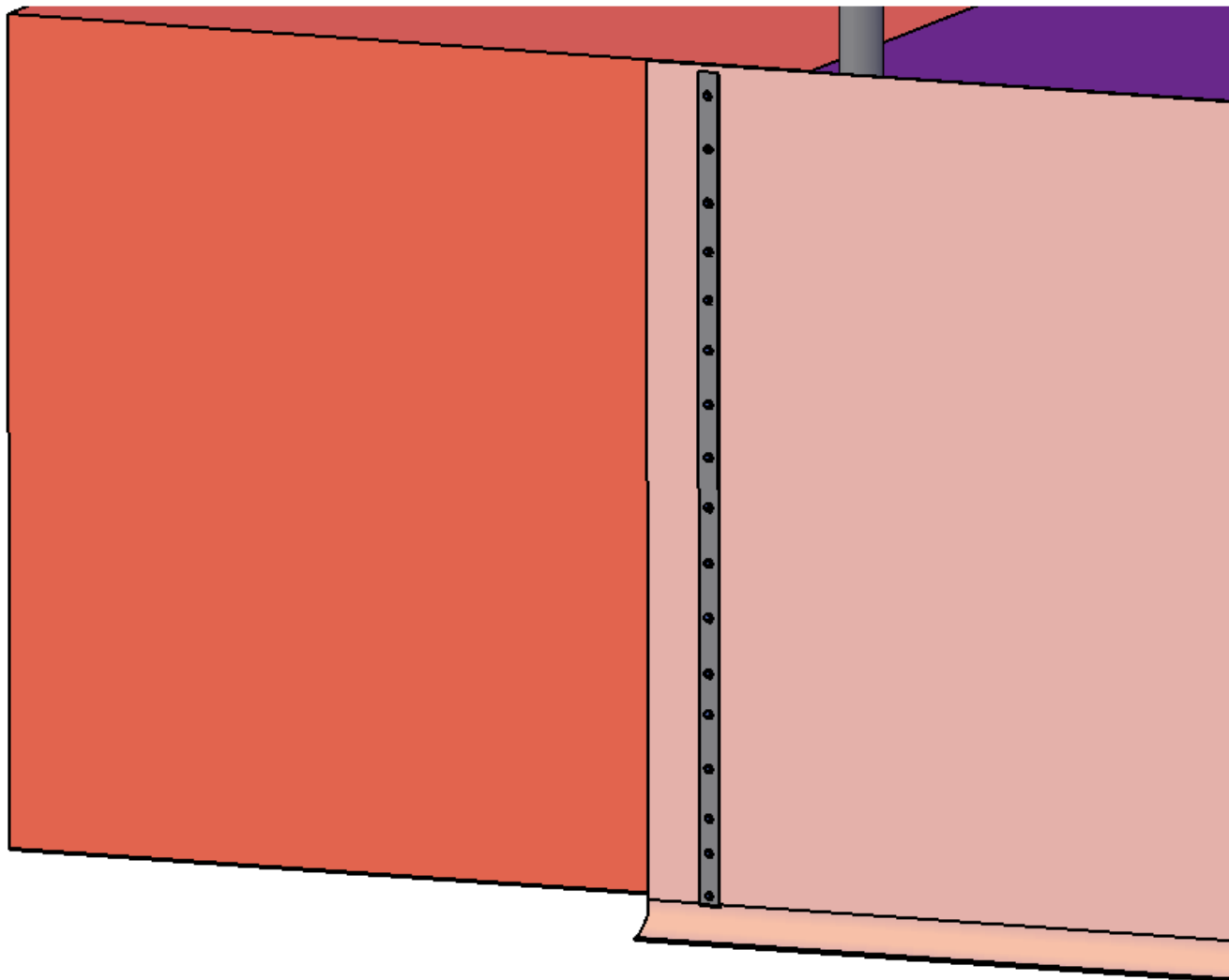

Use rope fasten door cover to door frame.

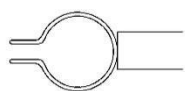

Same like frame fasten with frame with metal plate, cover also could be screw with container, so you have a better closed end panel, and you need special tool for this installation too.

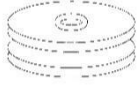
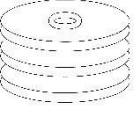

Extra part for sliding door

Fabric bar 1840mm			2
Fabric bar 1840mm			1
Single roller bracket			2
Double roller bracket			1
Single roller			2
Double roller			1
Screw M10x40 (tube 76mm)			2
Screw M10x60 (tube 11,12)			1
Screw M10x30 (tube 76mm+50mm)			3

8x1800mm rope			1
---------------	--	---	---

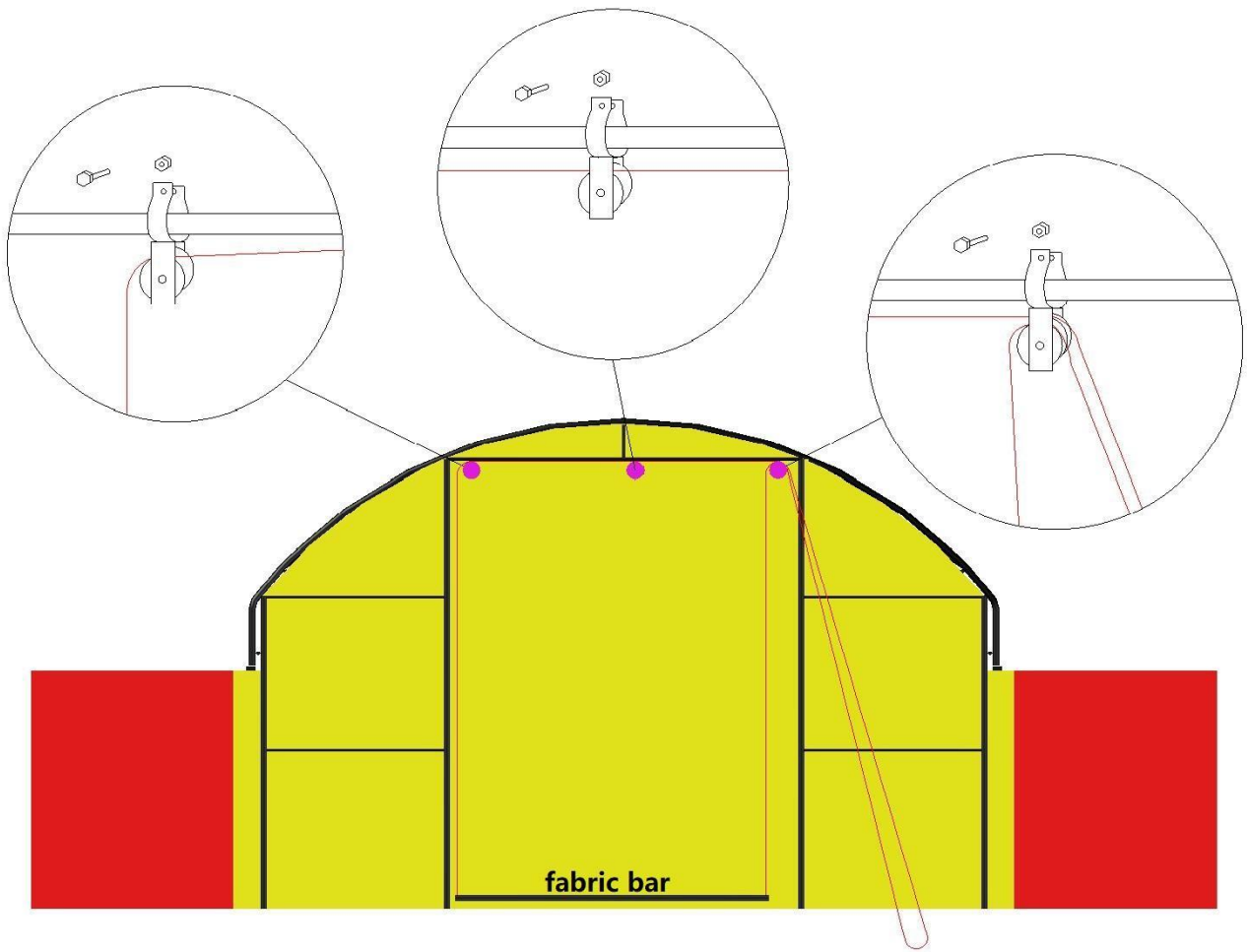

While you rolling up or put down sliding door, make sure no one standing under door.

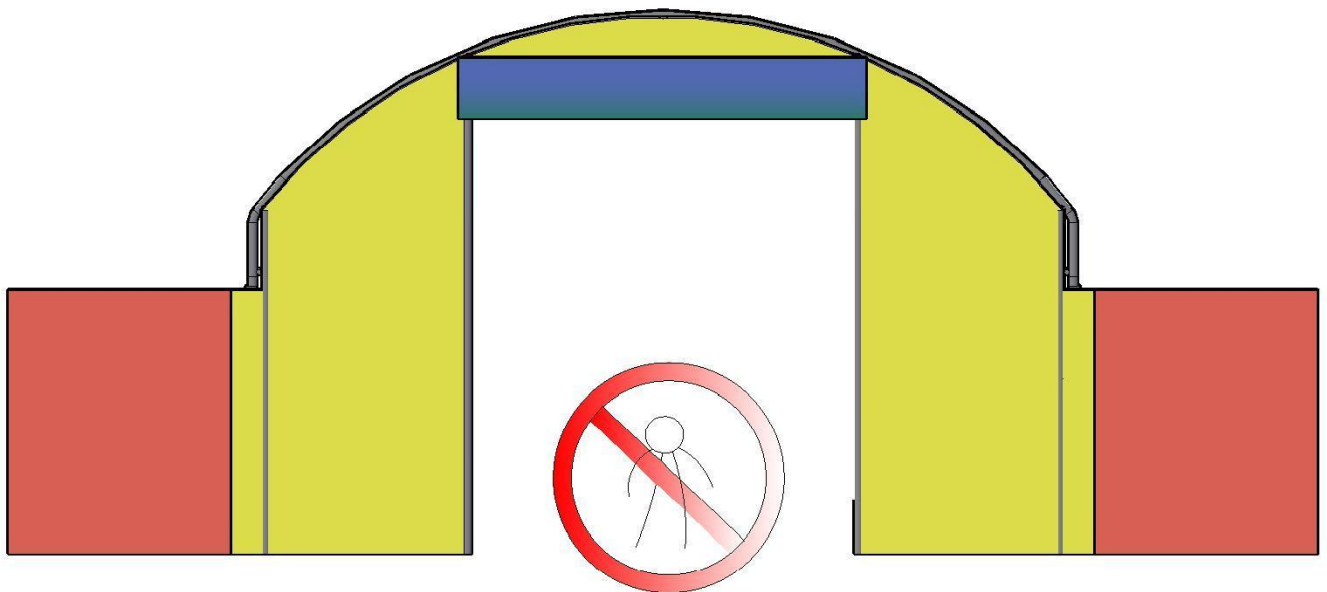

Put up roof cover, fasten cover with buckles, screw ring screw on corner fastener, hook tie down kit with ring screw to make roof cover tight.

