



























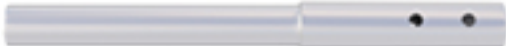
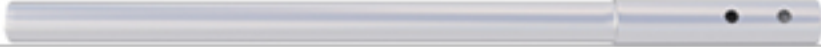







Name	No.	Picture	6 x 8	Extra 2 m	Extra 1 m
Tube dia. 50 mm (1890 mm)	1		14	2	2
Tube dia. 38 mm (1920 mm)	2		28	7	
Tube dia. 38 mm (930 mm)	3				7
Triple roof connector dia. 54 mm (Φ)	4		4		
Quad roof connector dia. 54 mm (Φ)	5		6	2	2
Corner foot	6		2		
Corner foot	7		2		
Foot	8		6	2	2
Entrance foot	9		4		
Roof bracing dia. 25 mm (Φ) (320mm)	10		5	1	1
Peg 8x300mm	11		4		
Peg 6x180mm	12		14	2	2
Peg 4x180mm	13		48	6	6
Rope	14		4		
Screw M6x35	15		12	2	2
Screw M8x50	16		64	10	10
Screw M8x70	17		72	12	12
Loop to mount the entrance	18		16		

Name	No.	List of additional parts	
Lifting tube: 0,5 m height	19		
Lifting tube: 1 m height	20		
Reinforcement	21		
Side cross cable, height: 2m	22		
Side cross cable, height: 2,5m	23		
Side cross cable, height: 3m	24		
Side cross cable, height: 3,5m	25		
Side cross cable, height: 4m	26		
Horizontal pipe (2 m) for the FR cover	27		
Horizontal pipe (2 m) for the FR cover	28		
Horizontal pipe (1 m) for the FR cover	29		
Horizontal pipe inserted into FR cover (2 m)	30		
Horizontal pipe inserted into FR cover (1 m)	31		
Horizontal reinforcements for entrances width: 5m	57		
Horizontal reinforcements for entrances width: 6m	67		
Horizontal reinforcements for entrances width: 8m	87		
Roof cross cable for width 4m	48		
Roof cross cable for width 5m	58		
Roof cross cable for width 6m	68		
Roof cross cable for width 8m	88		

STEP 1

The tent should be deployed on the flat surface.

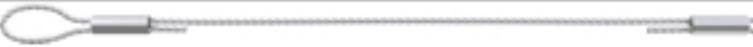
For the tents with the even length of the side eg. 8m, 10m, 12m, 20m, 30m,

Distribute the parts as pictured below. The connectors's **(6)** longer side should be facing the connector **(A3)**. Assemble all the dia. 50 mm (Φ) tubes **(2)** with the connectors using the M8x70 screws. The dia. 38 mm (Φ) tubes **(61)** should be assembled with the screws M8x50.

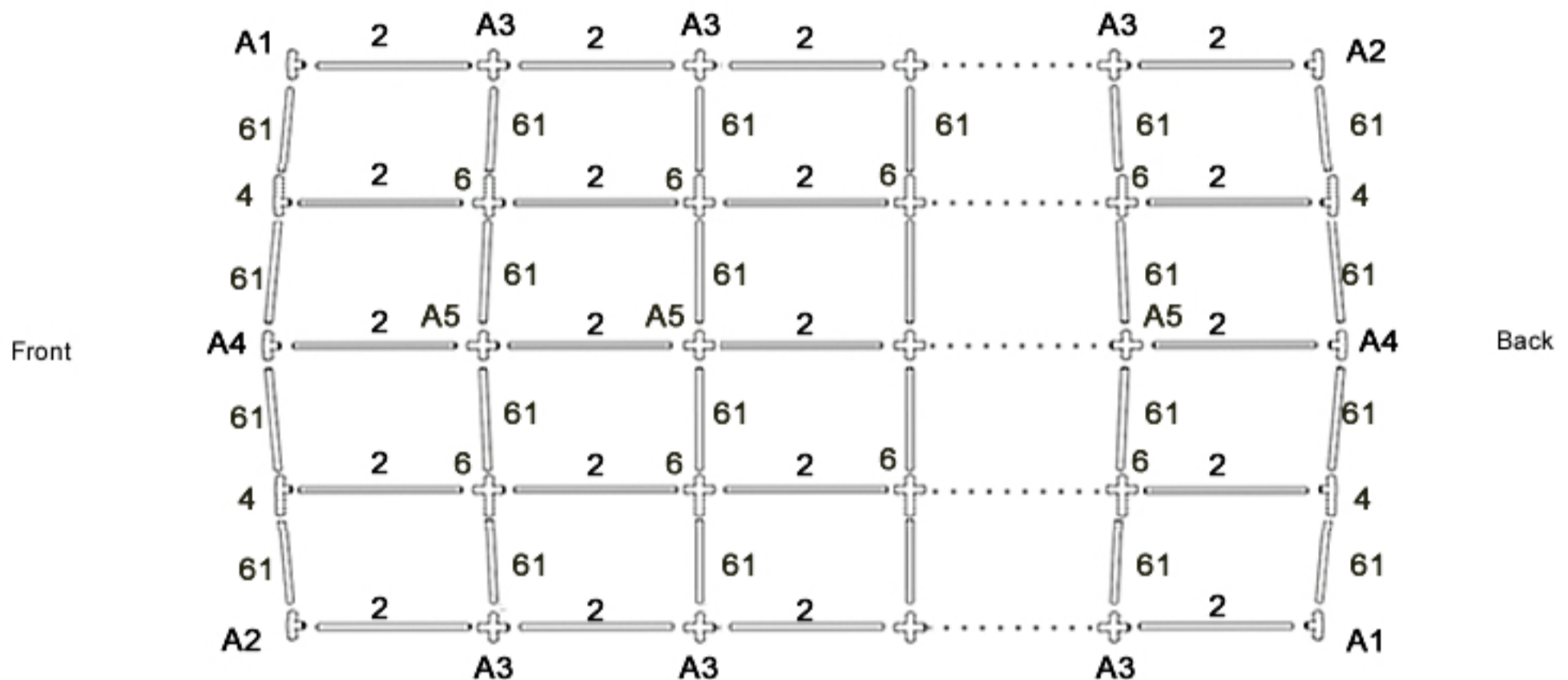

For the tents with the uneven length of the side eg.: 9m, 11m, 13m, 21m, 31m.....

Distribute the parts as pictured below. The connectors's **(6)** longer side should be facing the connector **(A3)**. Assemble all the dia. 50 mm (Φ) tubes **(2)** with the connectors using the M8x70 screws. The dia. 38 mm (Φ) tubes **(61)** should be assembled with the screws M8x50.

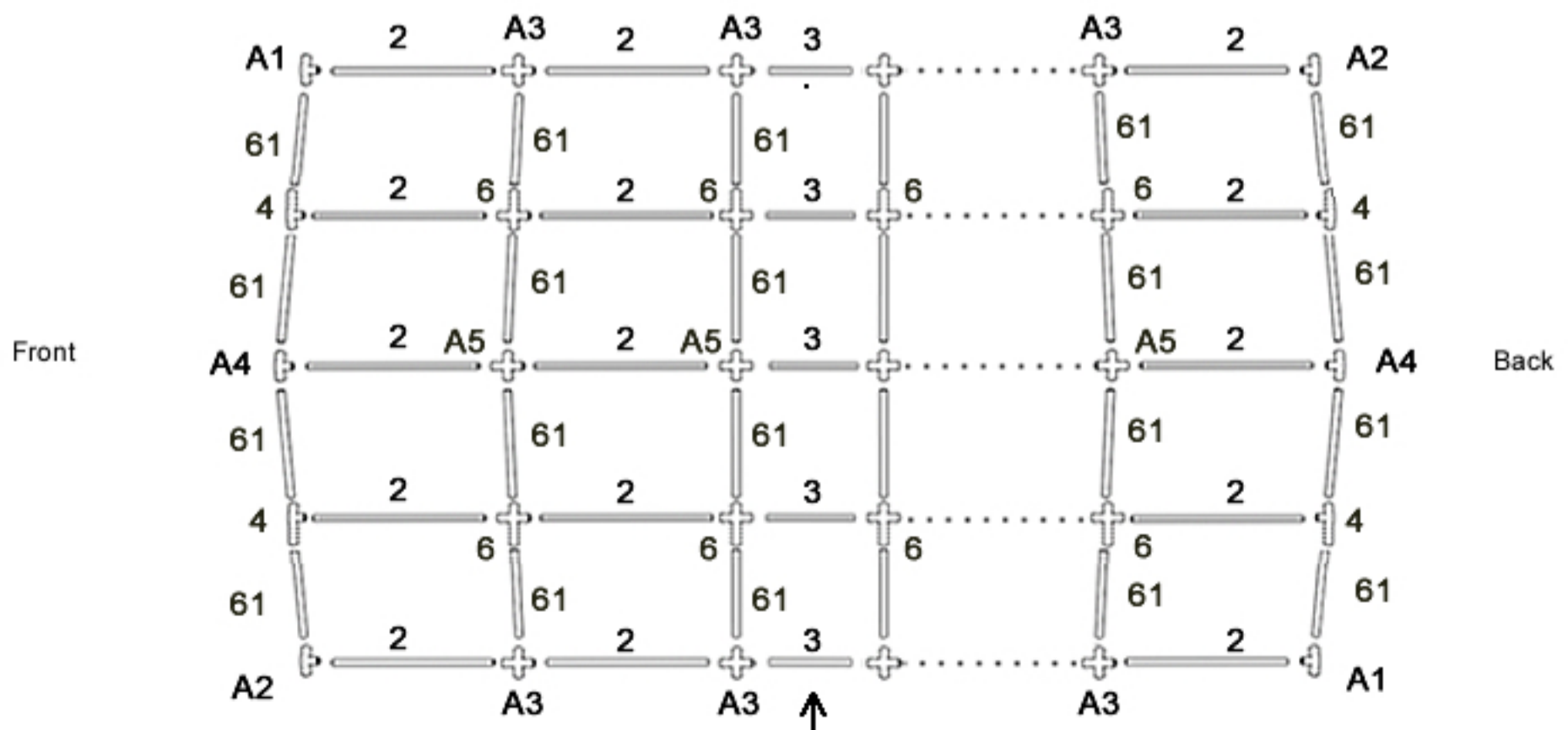

The extension tube should be located
in the third section.

STEP 2/a

- 1** Assemble together the roof connectors (**A4**) and (**A5**) with the horizontal bracings (**10**) using the M6x35 screws.

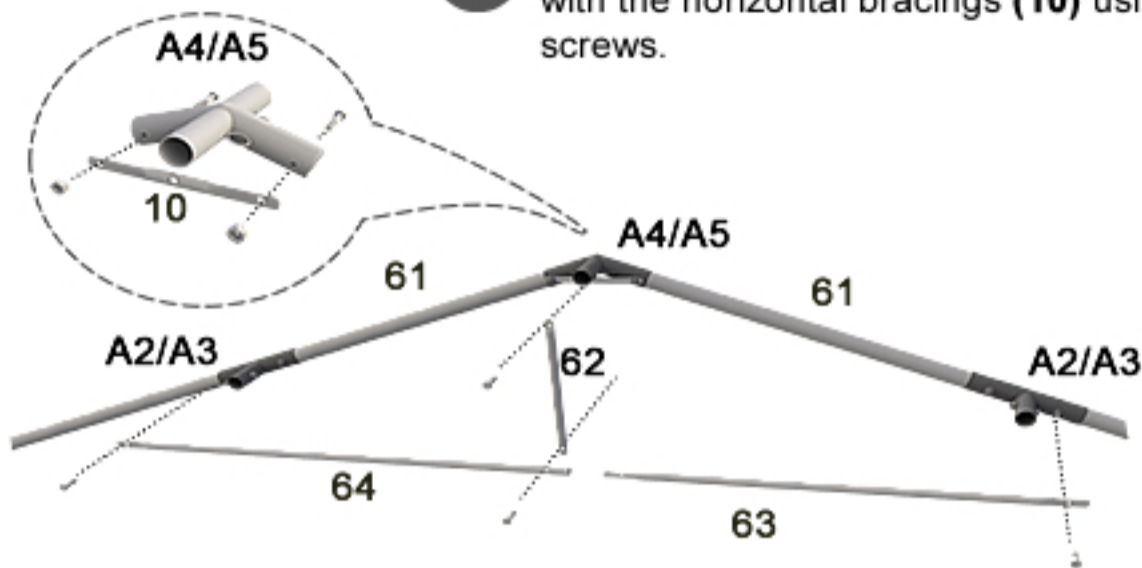

- 2** Assemble together horizontal bracings (**64**) and (**63**) using the M6x35 screws.

Connect the obtained construction to the lower part of the connectors (**A2** or **A3**). The middle of the assembled part connect with the horizontal bracing (**10**) using the vertical roof bracing (**62**).

- 3** Fully assembled roof structure should look like on the picture on the side.

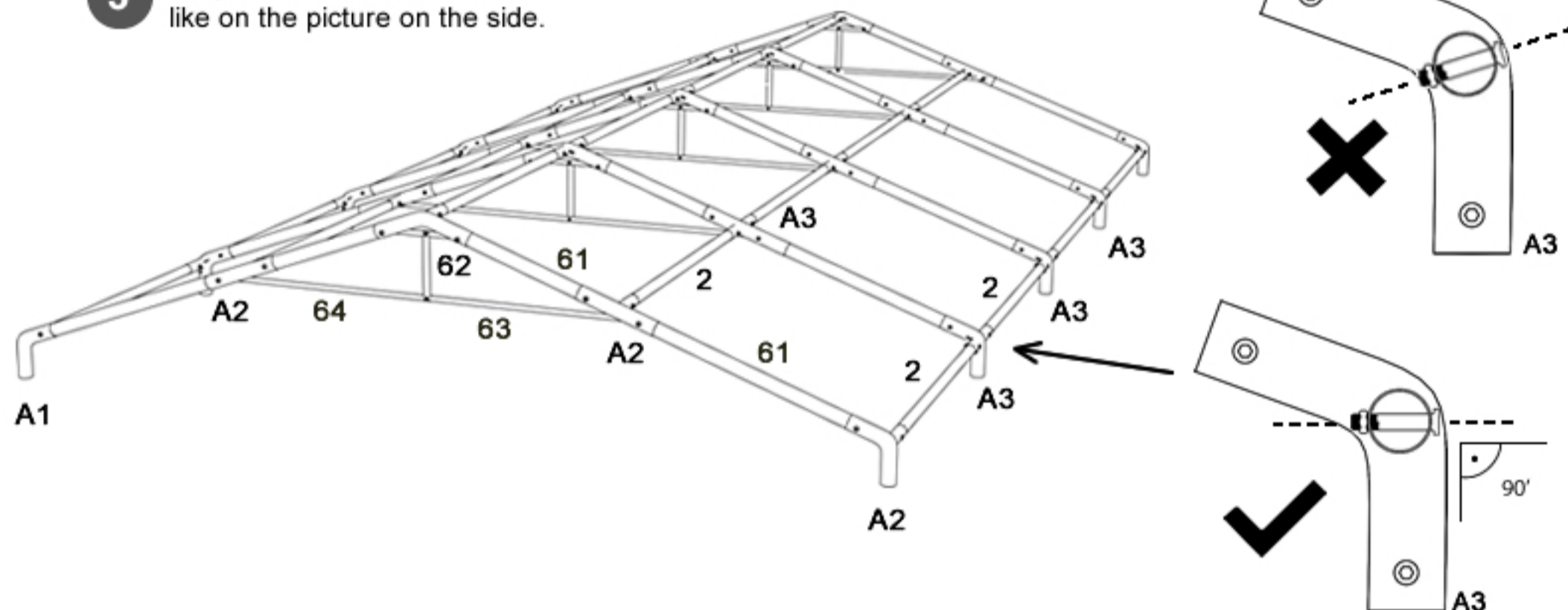

 The tent with the roof pulls (optional).

On the both sides of the tent mount the cross cables (**68**) every two sections. The cables should cross in the middle. Start with the connectors (**A4**) and (**A2**). Every cable should be mounted above the roof construction.

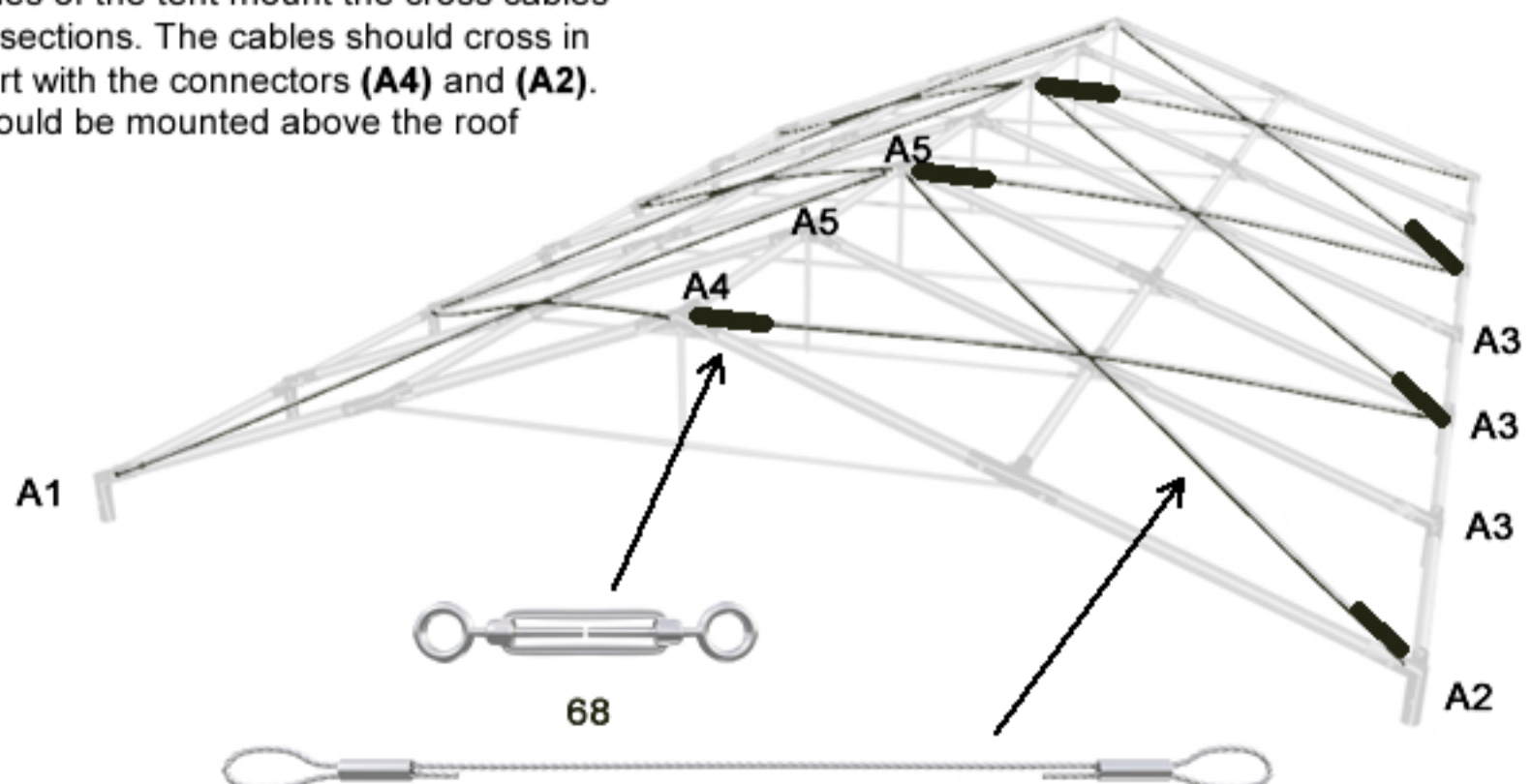

STEP 3

Table of parts for the heights:

Height	Parts
2m	no.1 (Picture no.1)
2,5m	no.1 + no.19 (Picture no.2)
3m	no.1 + no.20 (Picture no.2)

Table of parts for the heights:

Height	Parts
3,5m	no.1 + no.20 + no.19 (Picture no.3)
4m	no.1 + no.20 + no.20 (Picture no.3)

Gently lift the tent on one side and mount the tubes **(1)**. The three symmetrical holes in the pipe should be facing downwards. Next, lift the tent on the other side and repeat the action.

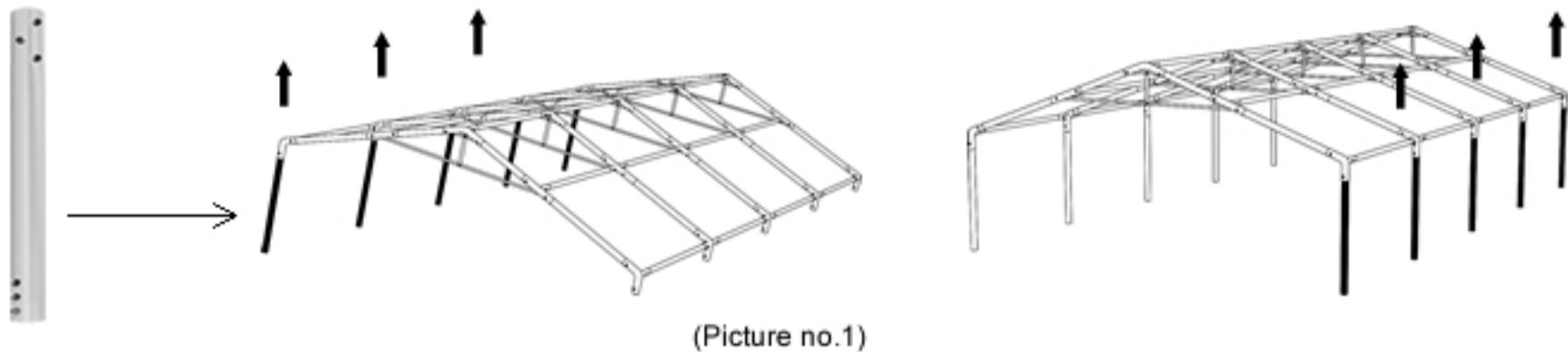

STEP 3/a

 For the 2,5 or 3m height.

Lift the tent with the pipes **(1)** installed on the one side and mount the 0,5 m lifting tubes **(19)** for the tent height 2,5 m, or 1m lifting tubes **(20)** for the tent height 3 m. Then, lift the tent on the other side and repeat the action.

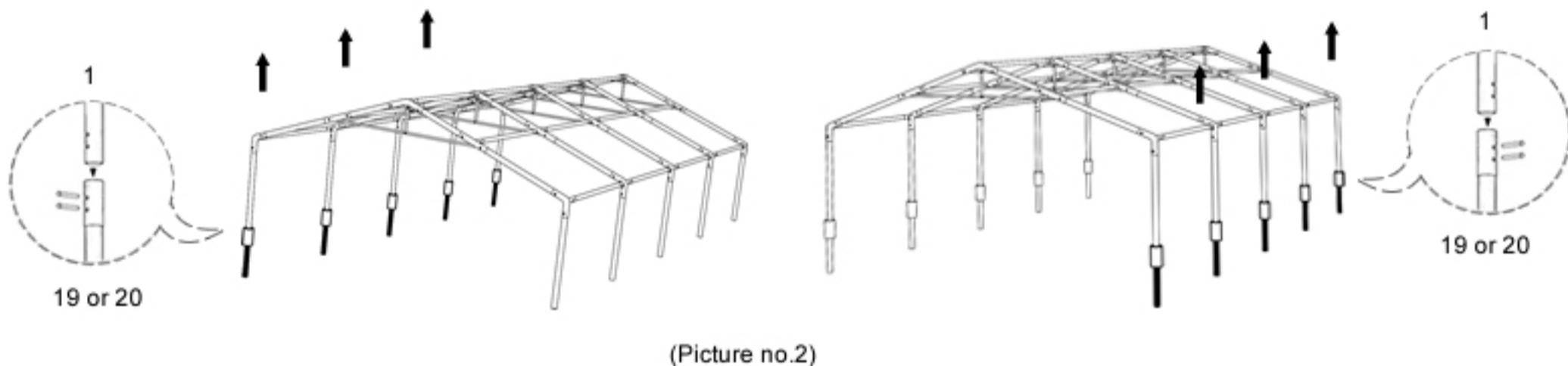

STEP 3/b

 For the 3,5 or 4m height.

Lift the tent with the lifting tubes **(19 or 20)** installed on the one side; next, mount the 0,5 m tubes **(19)** or 1m tubes **(20)**. Then, lift the tent on the other side and repeat the action.

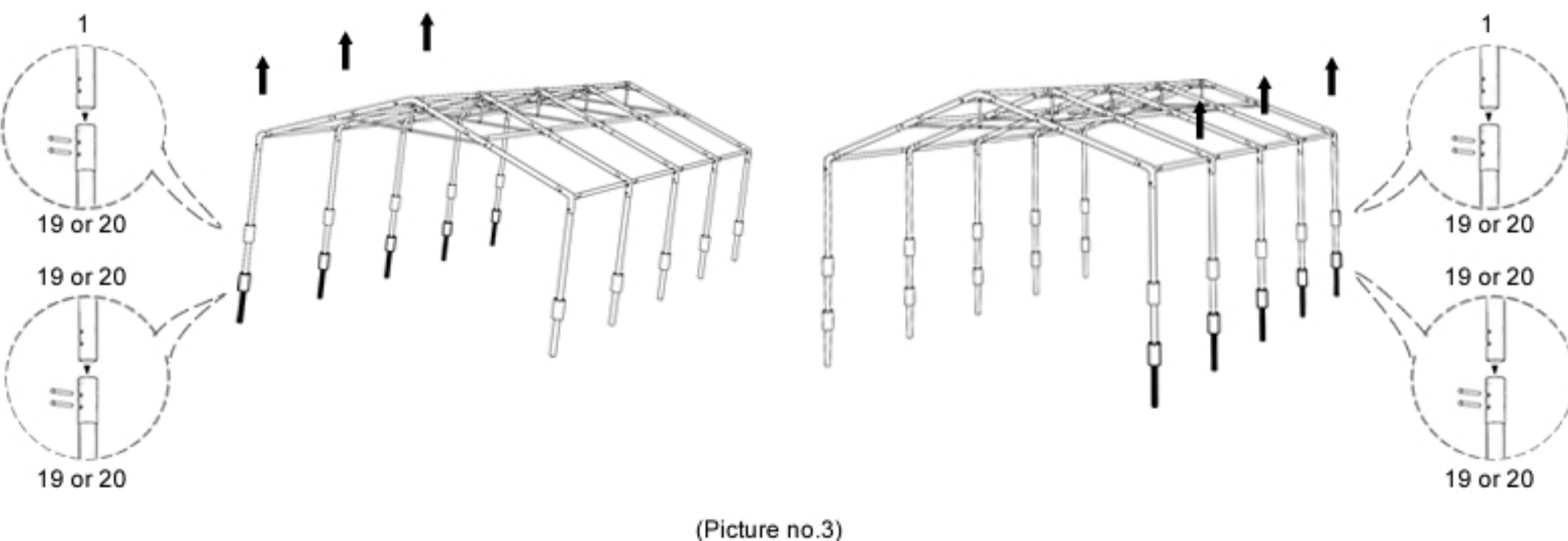

STEP 4

Mount diagonally the corner feet **(6)**, and next, feet **(7)** to the construction of the tent. On the side of the construction mount feet **(8)** and connect them to the tubes **(2)**. For the tents with the uneven side length, mount the extension **(3)** in the third section. Next install the feet **(9)** on the back and the front; connect them with the corner feet using the tube **(65)**. All the feet should be mounted securely to the ground.

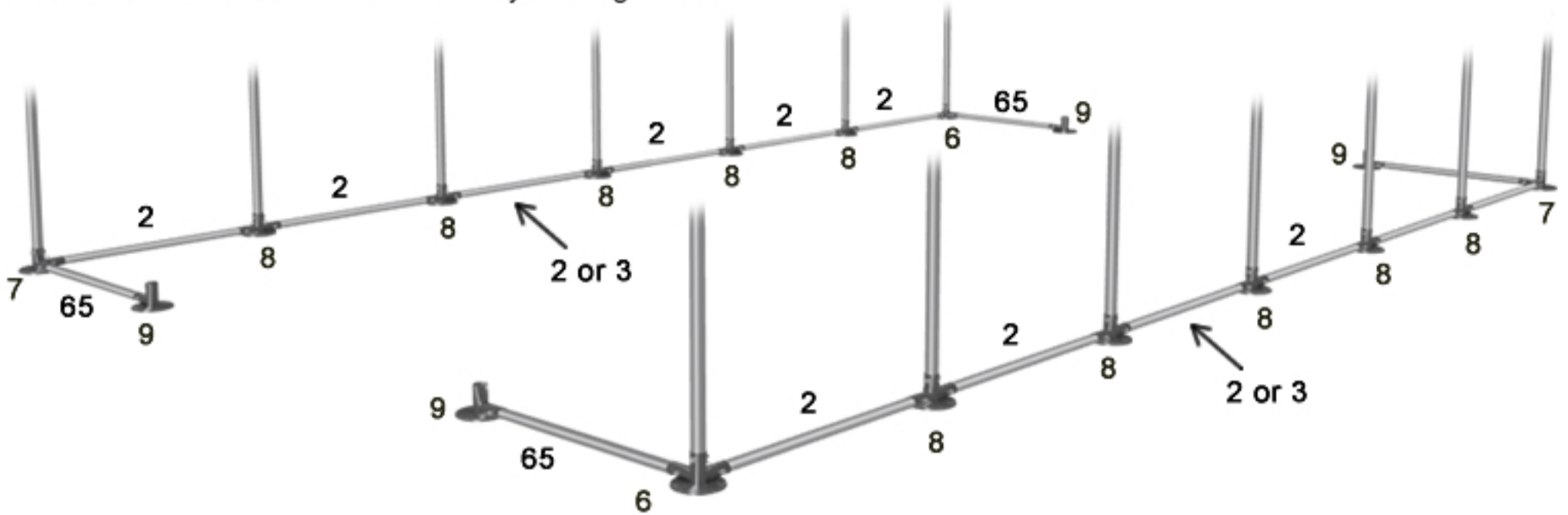

STEP 5

Connect the tubes **(1)** and **(66)**. These elements should be mounted to the entrance feet **(9)** and the connectors **(4)**. The connection with the connector **(4)** should be on the inside of the tent.

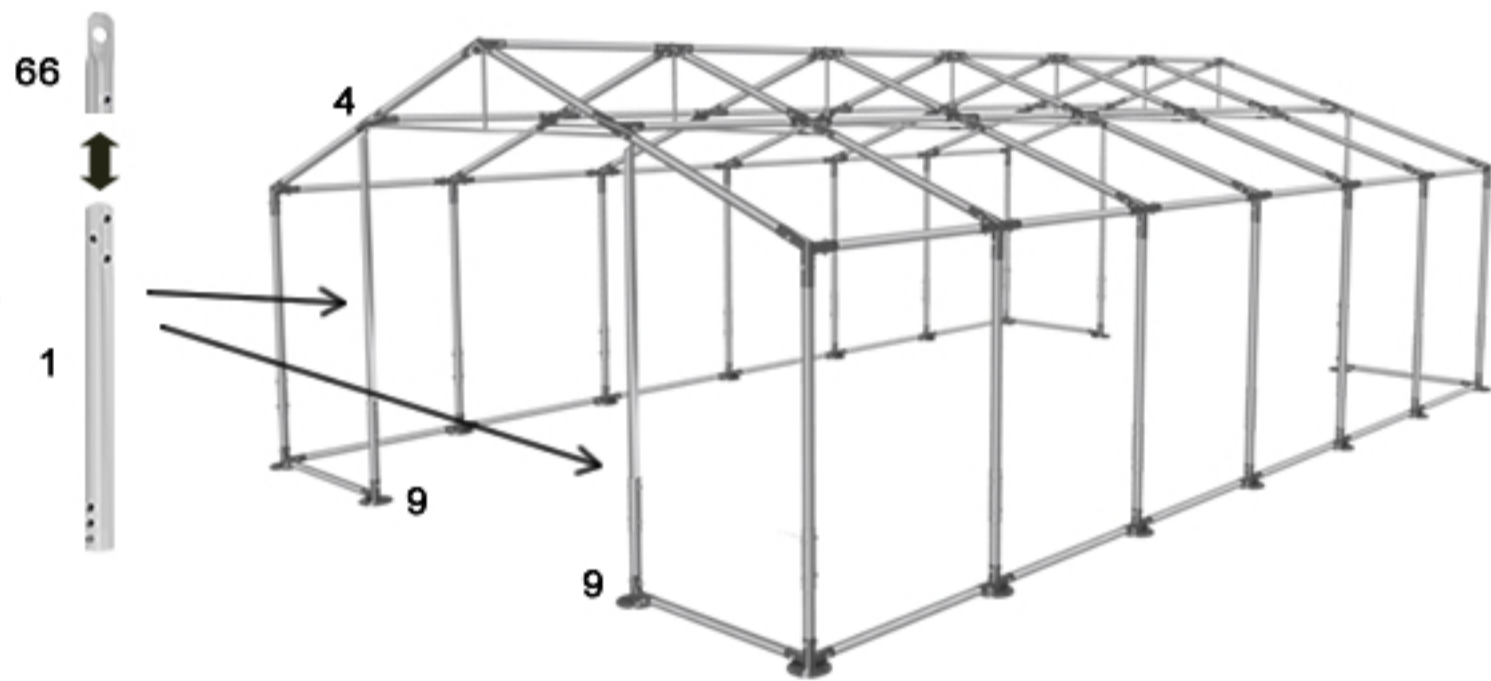

⚠ Tent with the side pulls. (optional)

On the both sides of the tent install the side pulls every two sections. The pulls should cross in the middle. Mount the pulls starting from the connector **(A2)** and foot **(6)**. On the other side start from the connector **(A1)** and foot **(7)**. All the pulls should be mounted on the outer side of the construction.

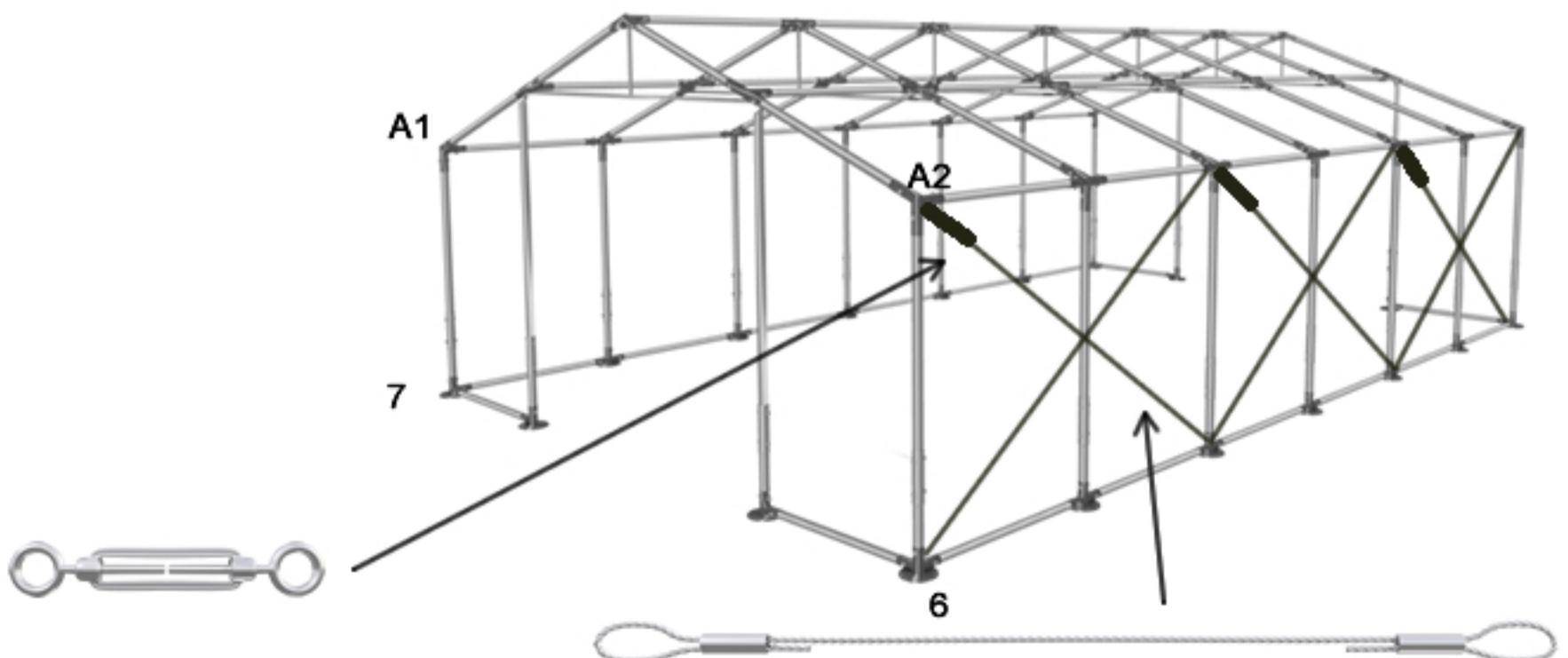

⚠ Tent with the single reinforcements - Polar (optional)

The reinforcement **(21)** should be connected to the vertical tube **(1)** and roof tube **(61)**.
The reinforcements should be placed on the inside of the tent.

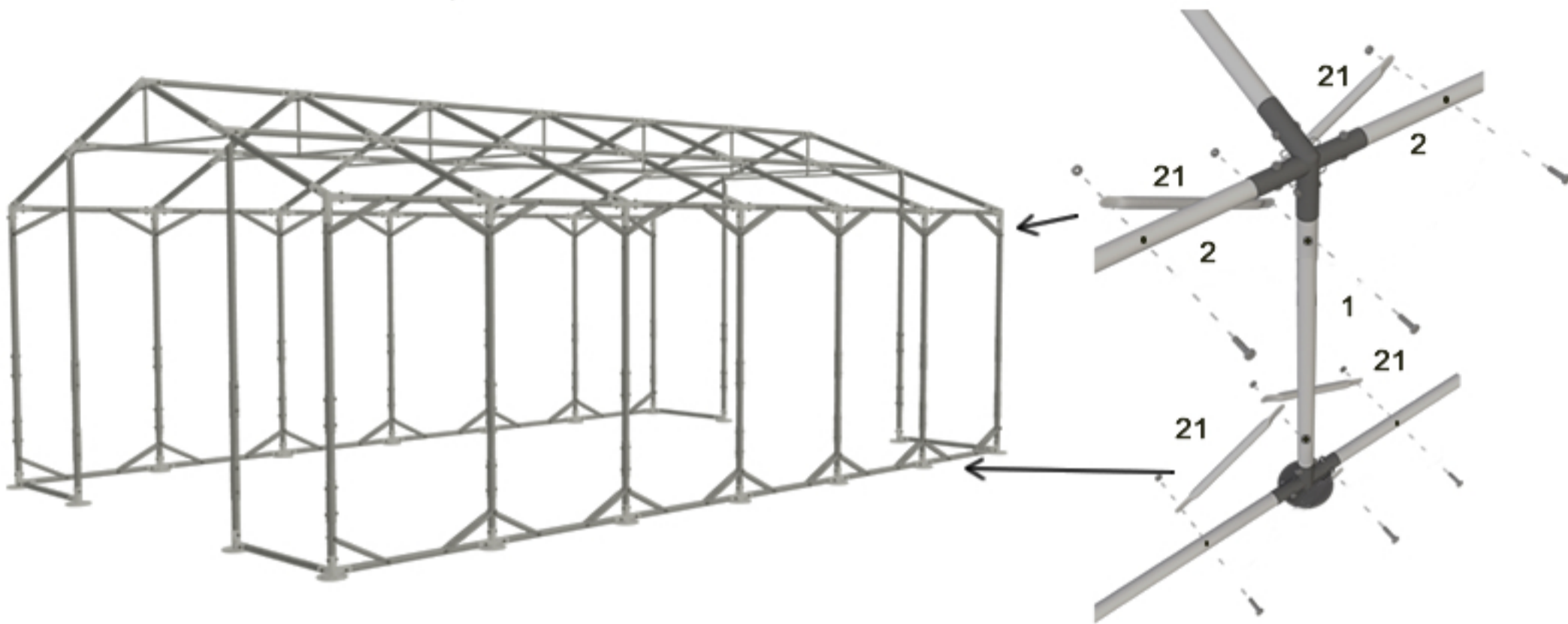

⚠ Tent with the double reinforcements - Polar Plus (optional)

Two reinforcements **(21)** should be connected to the vertical tube **(1)** and roof tube **(2)**.
The reinforcements should be mounted on the either inside and outside sides of tubes **(1)** and **(2)**.

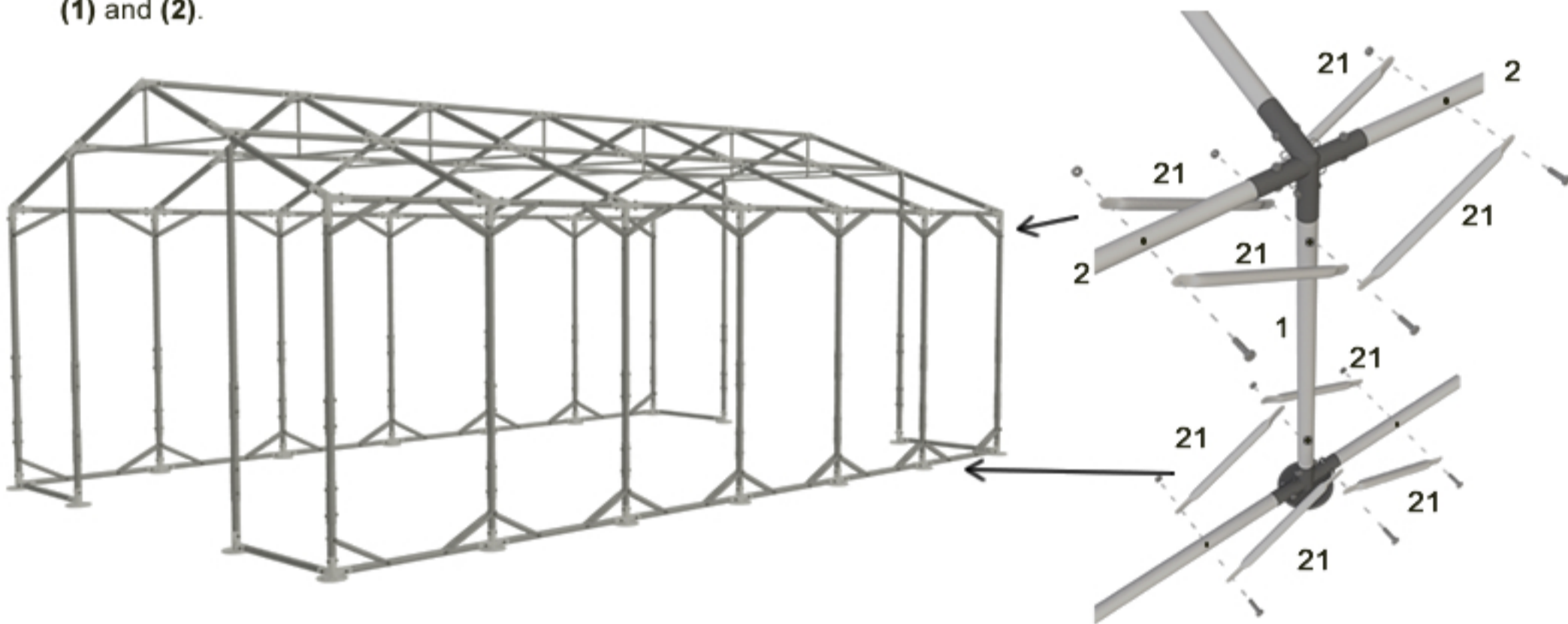

⚠ For the tent above 2m height (Polar plus)(optional)

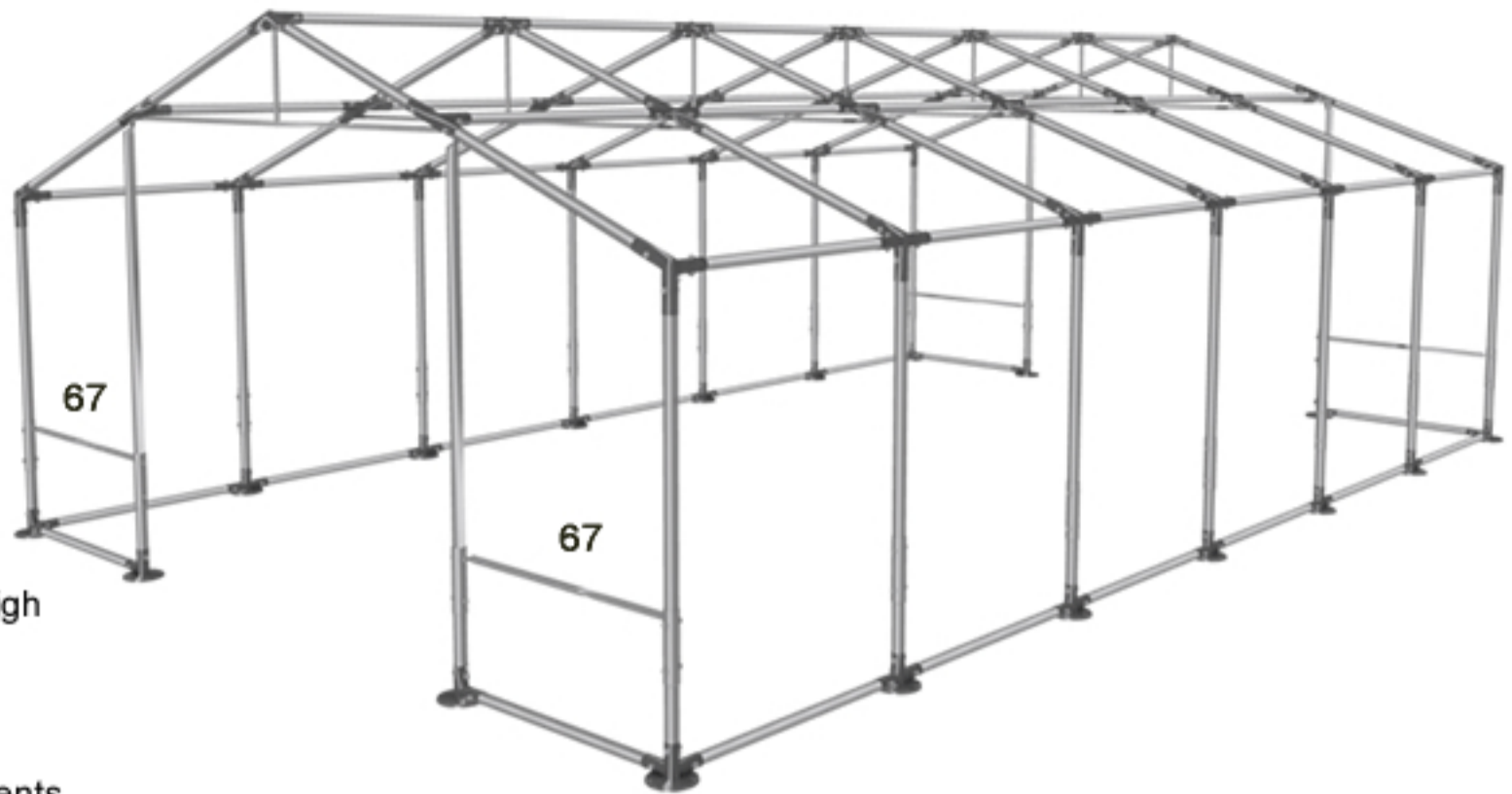

For the tents above 2m height (in Polar Plus version) we mount horizontal reinforcements **(67)** at the entrances. The reinforcements should be mounted to the cup of horizontal extension pipe.

⚠ Tent with the single reinforcements - Polar (optional)

The side reinforcement **(21)** should be connected to the vertical tube **(1)** and roof tube **(61)**.

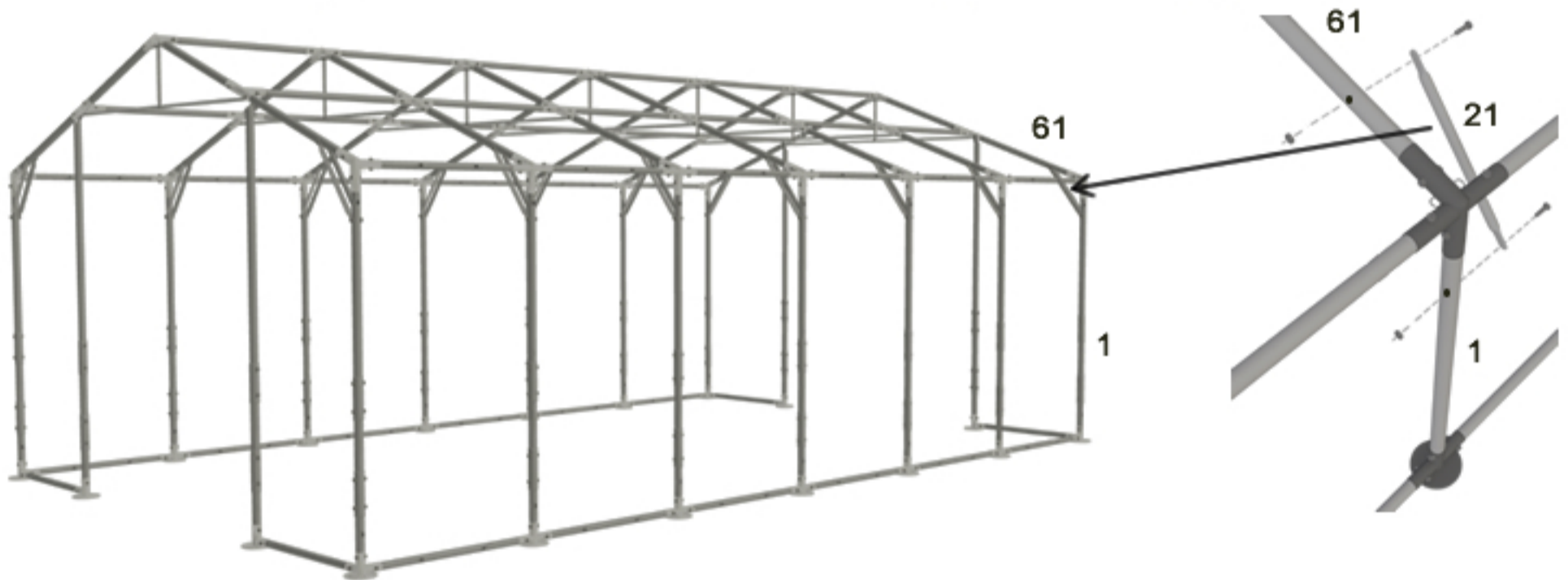

⚠ Tent with the double reinforcements - Polar Plus (optional)

Two reinforcements **(21)** should be connected to the vertical tube **(1)** and the roof tube **(61)**.

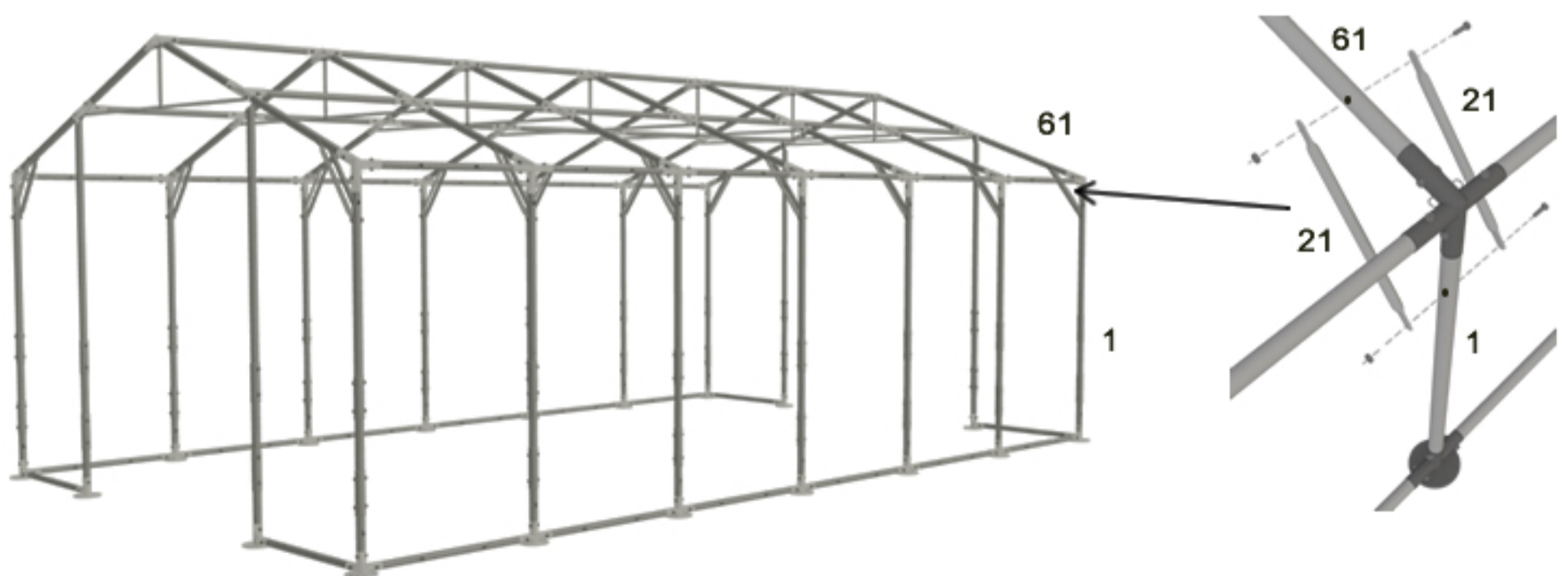

STEP 6

For the tents with the side panels height 2 m mount the panels with the drainage apron facing downwards.

For the tents with the side panels height above 2 m you need to connect the basic panel with the lifting panel(s).

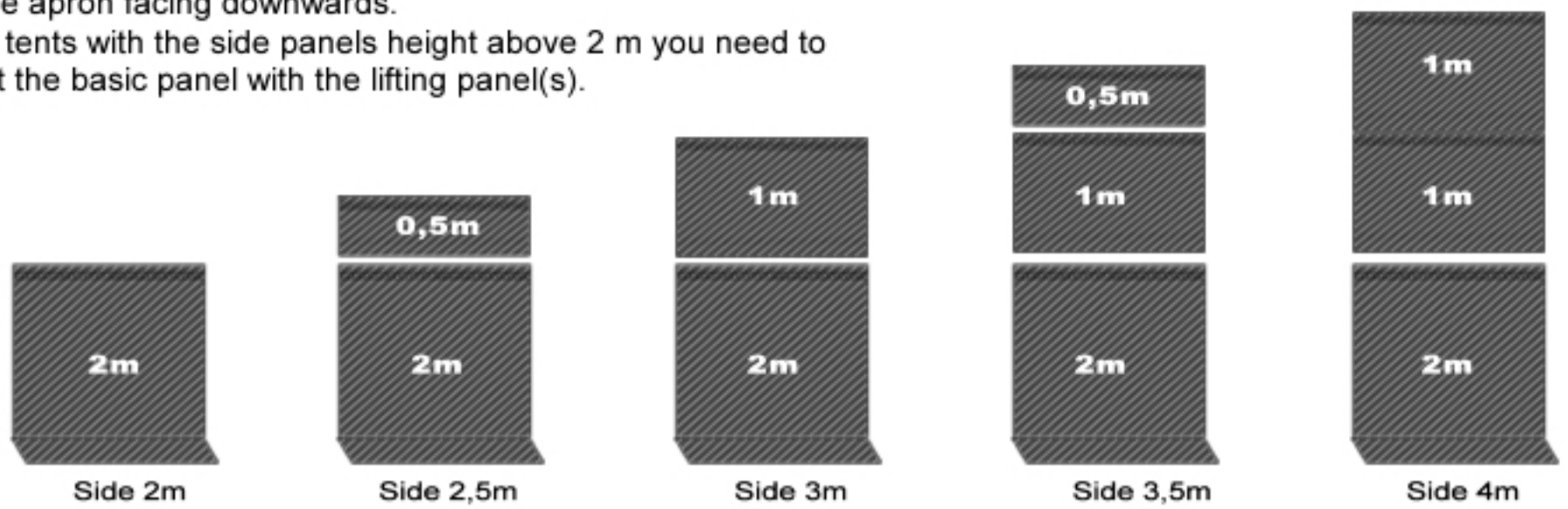

Assembled panels are ready to be mounted using the velcros on the roof. In order to fix the panels on the sides the elastic rubber with the ball should be used.

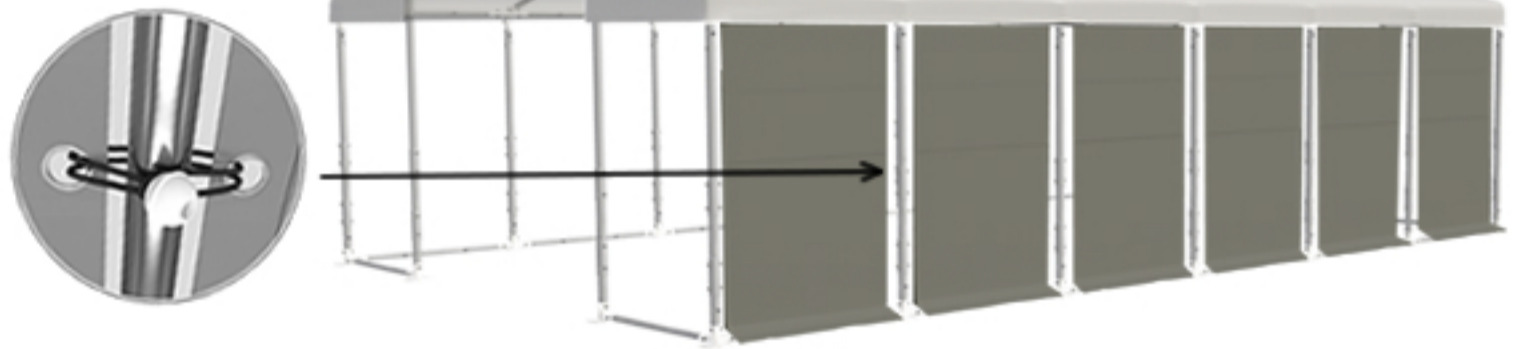

Mount the entrances on the both sides of the tent. Use metal loops (**18**) to mount the upper part of the entrance to the vertical tube (**63** and **64** put together). Sides of the entrance fix using the elastic rubbers with the balls.

Attach the masking stripes. If the tent's side panel's height is above 2 m, connect the masking stripes like the side panels (see the picture below). Each of the four wider masking stripes should be fixed on each side of the tent.

